

# Slim**PAR**<sup>TM</sup> **64**

## User Manual

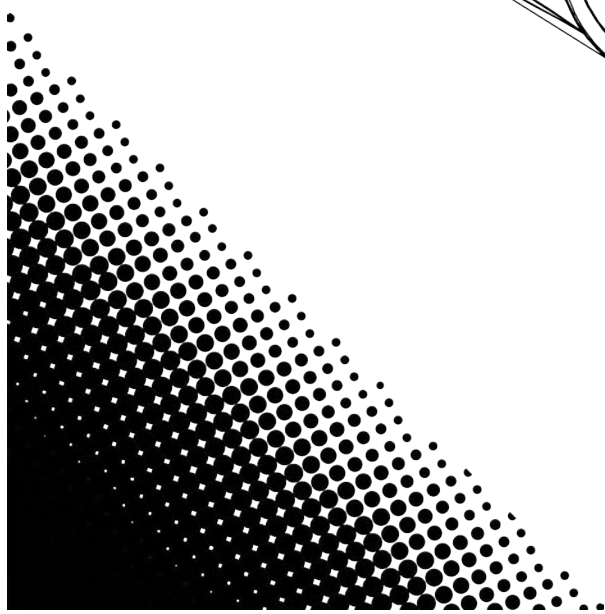
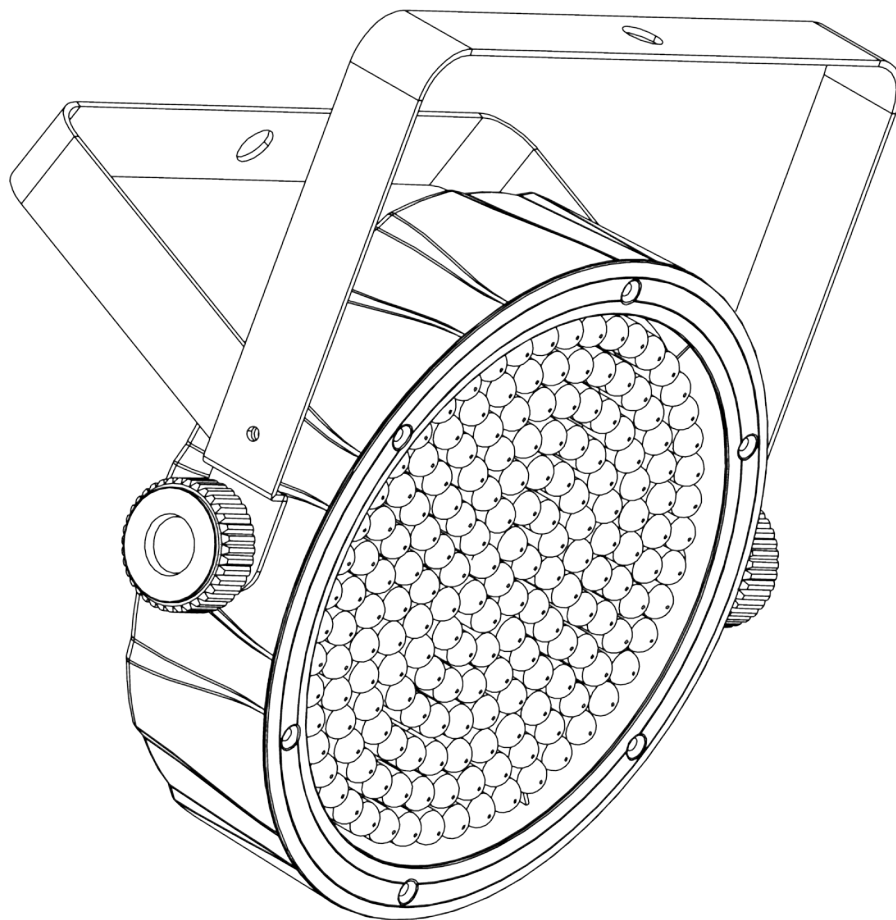

**CHAUVET**<sup>®</sup>  
*Value • Innovation • Performance*  
It's **Green** Thinking.<sup>™</sup>

The Chauvet logo features a stylized 'M' shape above the brand name. The tagline "It's Green Thinking" includes a small globe icon for the letter 'G'.

---

# TABLE OF CONTENTS

<b>1. Before You Begin.....</b>	<b>3</b>
What is Included.....	3
Unpacking Instructions .....	3
Text Conventions .....	3
Icons .....	3
Document Information .....	3
Product at a Glance.....	3
Safety Notes .....	3
<b>2. Introduction.....</b>	<b>5</b>
Product Overview.....	5
<b>3. Setup .....</b>	<b>5</b>
AC Power.....	6
<i>Fuse Replacement</i> .....	6
<i>Power Linking</i> .....	6
<i>Mounting</i> .....	7
<i>Orientation</i> .....	7
<i>Rigging</i> .....	7
<b>4. Operation .....</b>	<b>8</b>
Control Panel Operation .....	8
Menu Map.....	8
Configuration (DMX).....	8
<i>Starting Address</i> .....	8
Configuration (Standalone).....	9
<i>Sound Active Mode</i> .....	9
<i>Automatic Mode</i> .....	9
<i>Static Mode</i> .....	9
<i>Custom Static Colors</i> .....	9
<i>Master/Slave Mode</i> .....	9
DMX Channel Assignments and Values.....	10
<i>7-CH Mode</i> .....	10
<i>3-CH Mode</i> .....	10
<b>5. Technical Information .....</b>	<b>10</b>
General Maintenance .....	10
<b>6. Technical Specifications .....</b>	<b>11</b>
Returns .....	12
Claims.....	12
Contact Us .....	12

# 1. BEFORE YOU BEGIN

## What is Included

- 1 x SlimPAR™ 64
- 1 x Power Cord
- 1 x Warranty Card
- 1 x User Manual

## Unpacking Instructions



Immediately upon receiving this product, carefully unpack it and check the container in which you received it. Make sure that you have received all the parts indicated above and that they are all in good condition. If the material inside the container (this product and any other accessory included with it) appears damaged from shipping, or if the container shows signs of mishandling, notify the shipper immediately. In addition, retain the container and all the packing material for inspection.

See the *Claims* section in the *Technical Information* chapter.

## Text Conventions

Convention	Meaning
<Menu>	A key to be pressed on the fixture's control panel
1~512	A range of values
50/60	A set of values of which only one can be chosen
<i>Claims</i>	A section or chapter in this document
<b>Settings</b>	A menu option not to be modified (for example, showing the operating mode/current status)
<b>Menu &gt; Settings</b>	A sequence of menu options to be followed
ON	A value to be entered or selected

## Icons











Icon	Meaning
	Critical installation, configuration, or operation information. Failure to comply with this information may render the fixture partially or completely inoperative, cause damage to the fixture, or cause harm to the user.
	Important installation or configuration information. Failure to comply with this information may prevent the fixture from functioning correctly.
	Useful information.

## Document Information

The information and specifications contained in this document are subject to change without notice. CHAUVET® assumes no responsibility or liability for any errors or omissions that may appear in this manual.

© Copyright 2012 CHAUVET®. All rights reserved. Printed in P.R.C. Electronically published by CHAUVET® in the United States of America.

## Product at a Glance

Use on Dimmer		Auto Programs	
Outdoor Use		Auto-ranging Power Supply	
Sound Activated		Replaceable Fuse	
DMX		User Serviceable	
Master/Slave		Duty Cycle	

## Safety Notes

Please read the following notes carefully **before starting to work** with this product. They include important safety information about its the installation, usage, and maintenance.



**Please read the following notes carefully because they include important safety information about the installation, usage, and maintenance of this product.**

- Keep this User Manual for future consultation. If you sell this product to another user, be sure that they also receive this document.
- Always make sure that the voltage of the outlet to which you are connecting this product is within the range stated on the decal or rear panel of the fixture.

- 
- This product is for indoor use only! To prevent risk of fire or shock, do not expose this fixture to rain or moisture.
  - Make sure there are no flammable materials close to the unit while operating.
  - Always install this product in a location with adequate ventilation, at least 20 in (50 cm) from adjacent surfaces.
  - Be sure that no ventilation slots on the unit's housing are blocked.
  - Always disconnect this product from the power source before cleaning it or replacing the fuse.
  - Make sure to replace the fuse with another of the same type and rating.
  - If mounting this product overhead, always secure it to a fastening device using a safety cable.
  - The maximum ambient temperature (Ta) is 104° F (40° C). Do not operate this product at higher temperatures.
  - In the event of a serious operating problem, stop using the unit immediately.
  - Never try to repair this product. Repairs carried out by unskilled people can lead to damage or malfunction. Please contact the nearest authorized technical assistance center.
  - Never connect this product to a dimmer pack.
  - Make sure the power cord is not crimped or damaged.
  - Never disconnect the power cord by pulling or tugging on the cord.
  - Never carry this product from the power cord or any moving part. Always use the mounting bracket.
  - Always avoid direct eye exposure to the light source when this fixture is on.

## 2. INTRODUCTION

### Product Overview

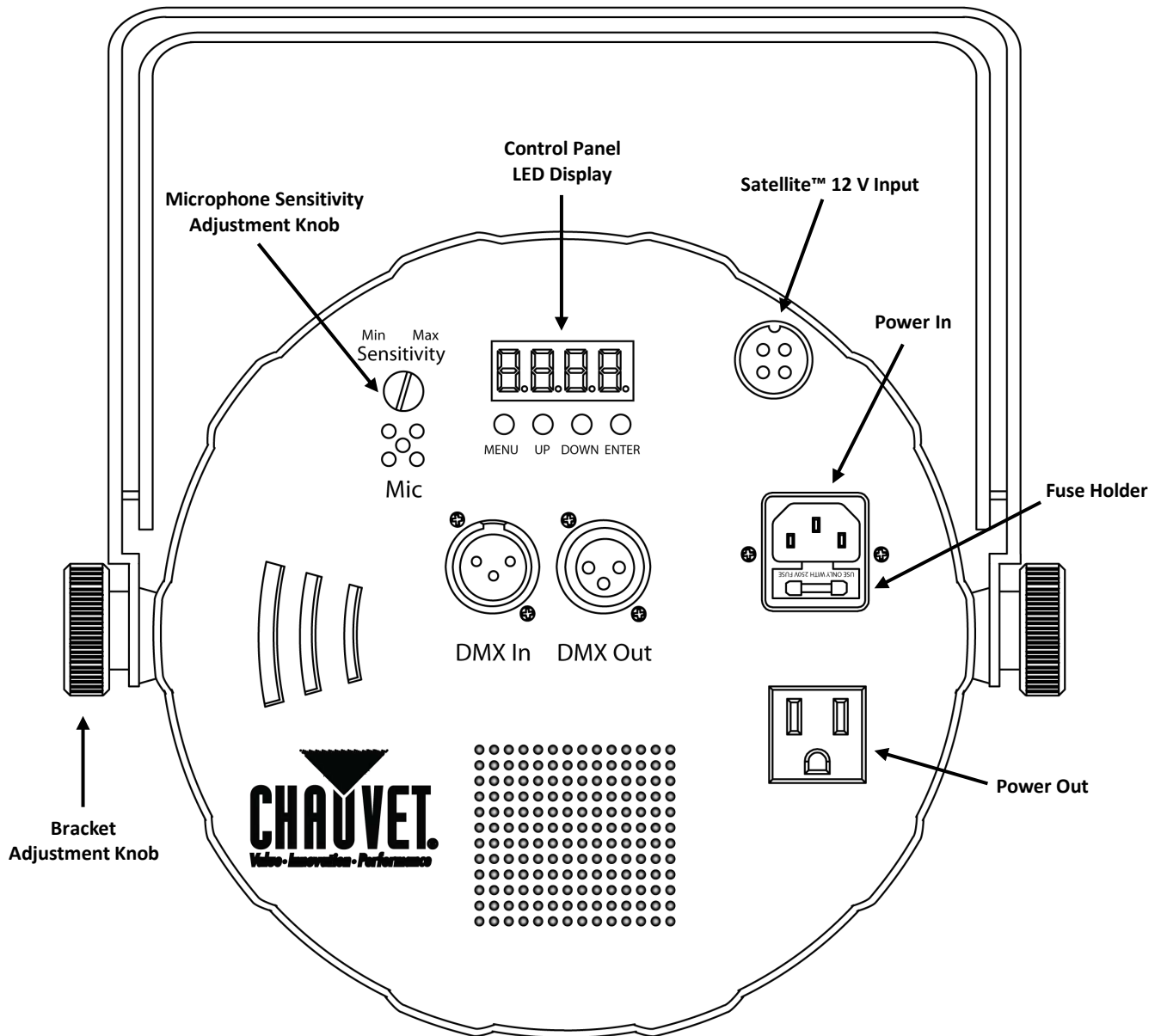

### 3. SETUP

#### AC Power

This product has an auto-ranging power supply and it can work with an input voltage range of 100~240 VAC, 50/60 Hz.

To determine the power requirements for a particular fixture, see the label affixed to the back plate of the fixture or refer to the fixture's specifications chart. A fixture's listed current rating indicates its average current draw under normal conditions.

**Always connect this product to a protected circuit (circuit breaker or fuse), making sure that it has an appropriate electrical ground to avoid the risk of electrocution or fire.**



**Never connect this product to a rheostat (variable resistor) or dimmer circuit, even if the rheostat or dimmer channel serves only as a 0 to 100% switch.**

#### Fuse Replacement

This fixture uses an F 1 A, 250 V fuse. Follow the instructions below to change it in case it blows.



**Disconnect this product from the power outlet before replacing the fuse.**

- 1) Wedge the tip of a flat-head screwdriver into the slot of the fuse holder and pry it out of its housing.
- 2) Remove the blown fuse from its holder and replace it with a fuse of the exact same type and rating.
- 3) Insert the fuse holder back in its place, and reconnect power.

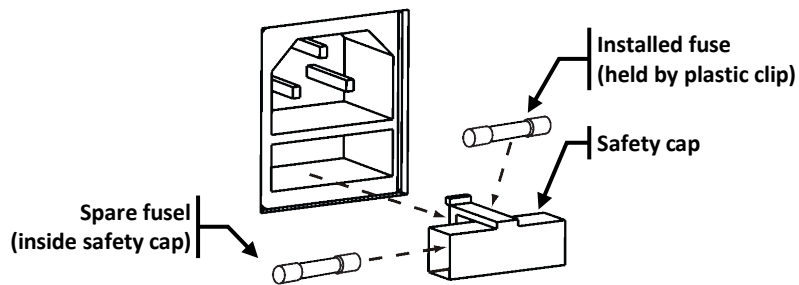

**This product ships with a spare fuse inside the safety cap, as shown above.**

#### Power Linking

This fixture provides power linking via the Edison outlet located in the front of the unit. Please see the diagram below for further explanation.

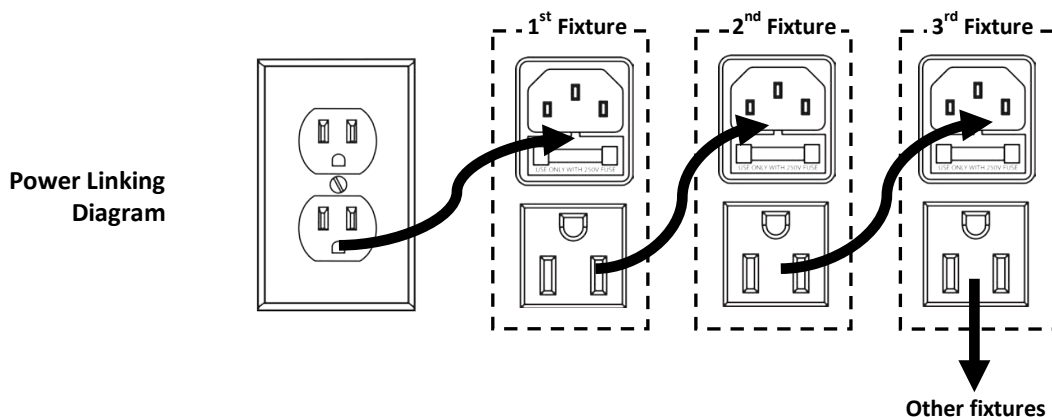

**You can power link up to 40 SlimPAR™ 64 units on 120 VAC or up to 60 SlimPAR™ 64 units on 230 VAC.**



**The power linking diagram shown above corresponds to the North American version of this product ONLY! If using this product in other markets, you must consult with the local CHAUVET® distributor as power linking connectors and requirements may differ in your country or region.**

---

**Mounting**

Before mounting this product, read and follow the safety recommendations indicated in the *Safety Notes* section (page 2 of this manual).

**Orientation**

The SlimPAR™ 64 may be mounted in any position, provided there is adequate room for ventilation around it.

**Rigging**

Before deciding on a location for this product, always make sure that it will be easy to access the unit for maintenance and programming purposes.

Make sure that the structure onto which you are mounting this product can support its weight. Please see the *Technical Specifications* section of this manual for weight information.

When mounting this product overhead, always use a safety cable. Mount the fixture securely to a rigging point, whether an elevated platform or a truss.

When rigging this product onto a truss, you should use a mounting clamp of appropriate weight capacity. The bracket has a 13 mm hole, which is appropriate for this purpose.

When power linking multiple fixtures, you must always consider the length of the power linking cable and mount the fixtures close enough for the cable to reach them.

The bracket knobs allow for directional adjustment when aiming the fixture to the desired angle. Only loosen or tighten the bracket knobs using your bare hands. Using tools could damage the knobs.

The double bracket yoke/mounting brackets/feet also serve as floor support(s) or surface mounting. When mounting this fixture on the floor, make sure that the fixture and its cables are away from people and vehicles.

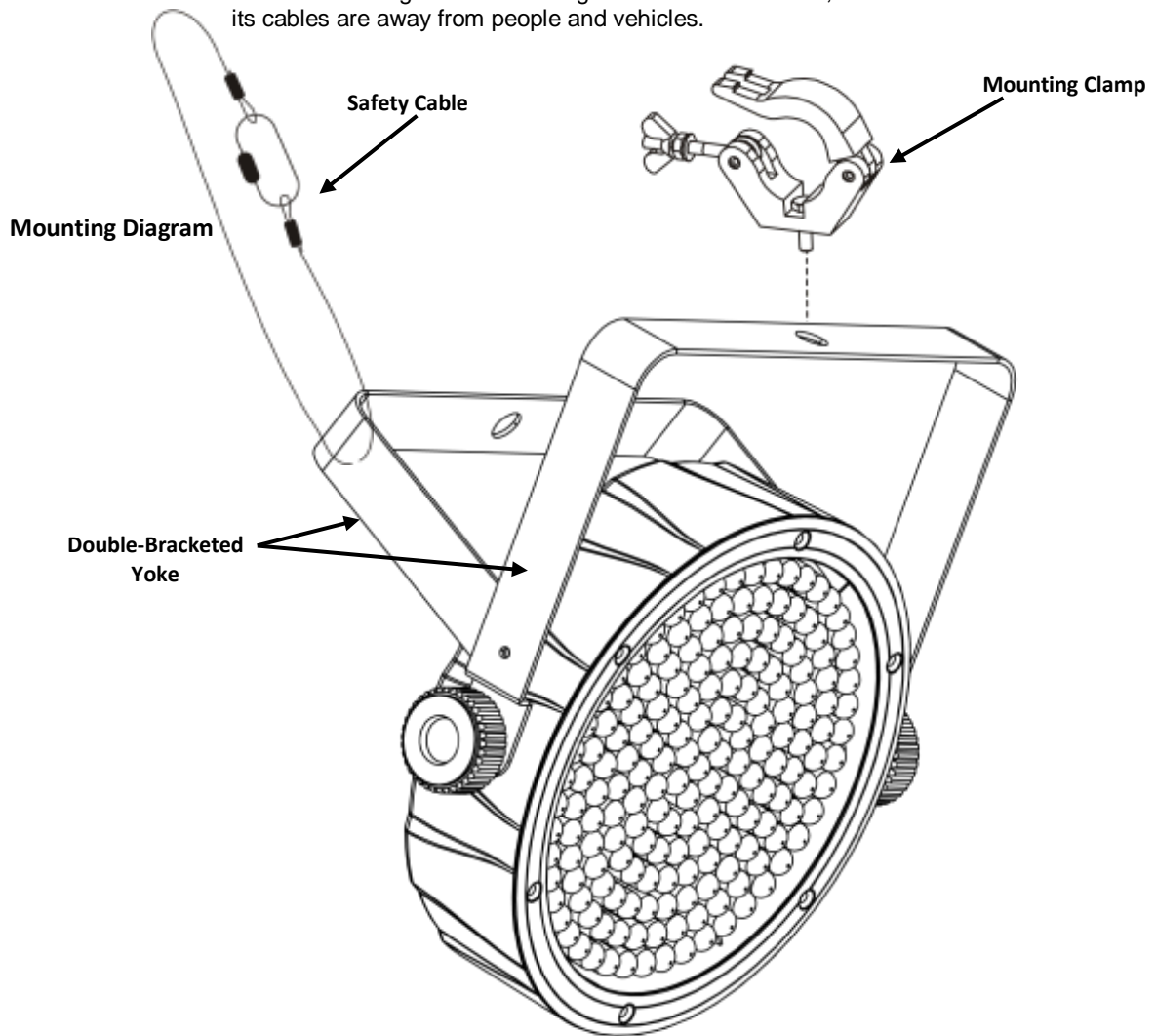

## 4. OPERATION

### Control Panel Operation

To access the control panel functions, use the four buttons located underneath the display. Please refer to the Product Overview (page 5) to see the buttons location on the control panel.

Button	Function
<MENU >	Press to find an operation mode or to back out of the current menu option
<UP>	Press to scroll up the list of options or to find a higher value
<DOWN>	Press to scroll down the list of options or to find a lower value
<ENTER>	Press to activate a menu option or a selected value

### Menu Map

Mode	Programming Steps		Description
P--	P1		7 color program (switching)
	P2		7 color program (fading)
	P3		3 color program (switching)
	P4		3 color program (fading)
	P5		7 color program (sound-active)
	P6		3 color program (sound-active)
3-CH	d001~d512		3-channel DMX mode (RGB)
7-CH			7-channel DMX mode
C--	C1	Red	Static
	C2	Green	
	C3	Blue	
	C4	Cyan	
	C5	Magenta	
	C6	Yellow	
	C7	White	
S--	S001~S100		Program speed for P1~P4
U--	r--	Red (r000~1000)	Custom Static Colors: Combine red, green, and blue
	g--	Green (g000~100)	
	b--	Blue (b000~100)	

### Configuration (DMX)

Set this product in DMX mode to control it with a DMX controller.

- 1) Connect this product to a suitable power outlet.
- 2) Turn this product on.
- 3) Connect a DMX cable from the DMX output of the DMX controller to the DMX input socket of this product.

### Starting Address

When selecting a starting DMX address, always consider the number of DMX channels the selected DMX mode uses. If you choose a starting address that is too high, you could restrict the access to some of the fixture's channels.

The SlimPAR™ 64 uses up to seven DMX channels in the 7-CH personality, which defines the highest configurable address to 507.

If you are not familiar with the DMX protocol, download the DMX Primer from [www.chauvetlighting.com](http://www.chauvetlighting.com).

To select the starting address, do the following:

- 1) Press <MENU> repeatedly until **3-CH** or **7-CH** shows on the display.
- 2) Press <ENTER>.
- 3) Use <UP> or <DOWN> to select the starting address (**d001~d507**).
- 4) Press <ENTER>.



---

## Configuration (Standalone)

Set this product in one of the standalone modes to control it without a DMX controller.

- 1) Connect this product to a suitable power outlet.
- 2) Turn this product on.



**Never connect a fixture that is operating in any standalone mode, whether Static, Automatic, or Sound to a DMX string connected to a DMX controller. This is because fixtures in standalone mode may transmit DMX signals that could interfere with the DMX signals from the controller.**

### Sound Active Mode

To enable the Sound Active mode, do the following:

- 1) Press <MENU> repeatedly until **P--** shows on the display.
- 2) Press <ENTER>.
- 3) Use <UP> or <DOWN> to select **P5** or **P6**.
- 4) Press <ENTER>.
- 5) Turn the music on and adjust the microphone sensitivity knob until the fixture starts reacting to the beat of the music.



**The fixture will only respond to the low frequencies of the music (bass and drums).**

### Automatic Mode

To enable the Automatic Mode, follow the instructions below:

- 1) Press <MENU> repeatedly until **P--** shows on the display.
- 2) Press <ENTER>.
- 3) Use <UP> or <DOWN> to select **P1~P4**.
- 4) Press <ENTER>.
- 5) Press <MENU> repeatedly until **S--** shows on the display.
- 6) Use <UP> or <DOWN> to adjust the speed at which the program plays (**S001~100**).
- 7) Press <ENTER>.

### Static Mode

To enable the Static mode, do the following:

- 1) Press <MENU> repeatedly until **C--** shows on the display.
- 2) Press <ENTER>.
- 3) Use <UP> or <DOWN> to select the preset color (**C1~C7**).
- 4) Press <ENTER>.

### Custom Static Colors

To enable the Custom Static Colors mode, do the following:

- 1) Press <MENU> repeatedly until **U--** shows on the display.
  - 2) Press <ENTER>.
  - 3) Use <UP> or <DOWN> to select the desired color: red (**r--**), green (**g--**), or blue (**b--**).
  - 4) Press <ENTER>.
  - 5) Use <UP> or <DOWN> to select the desired color value (**000~100**).
- NOTE:** Selecting **000** will turn the color off.
- 6) Press <ENTER> to continue to the next color.
  - 7) Repeat steps 5 to 7 until you create your desired color.
  - 8) Press <ENTER> to save the color.

### Master/Slave Mode

This mode allows a single SlimPAR™ 64 unit (the “master”) to control the actions of one or more SlimPAR™ 64 units (the “slaves”) without the need of a DMX controller. The master unit will be set to operate in either Automatic or Sound Active mode, while the slave units will be set to operate in Slave Mode. Once set and connected, the slave units will operate in unison with the master unit.

Configure the units as indicated below.

#### Slave units:

- 1) Press <MENU> repeatedly until **3-CH** or **7-CH** shows on the display.
- 2) Press <ENTER> to accept.
- 3) Use <UP> or <DOWN> to set the starting address to **d001**.
- 4) Press <ENTER>.
- 5) Connect the DMX input of the first slave unit to the DMX output of the master unit.
- 6) Connect the DMX input of the subsequent slave units to the DMX output of the previous slave unit.
- 7) Finish setting and connecting all the slave units.

#### Master unit:

- 1) Set the master unit to operate in either Automatic or Sound mode, as previously indicated.
- 2) Make the master unit the first unit in the DMX daisy chain.



- **Configure all the slave units before connecting the master unit to the DMX daisy chain.**
- **Never connect a DMX controller to a DMX string configured for Master/Slave operation because it may interfere with the signals from the master unit.**
- **Do not connect more than 31 slave units to the master unit.**

## DMX Channel Assignments and Values

7-CH Mode	Channel	Function	Value	Setting
	1	Red	000 ⇔ 255	0~100%
	2	Green	000 ⇔ 255	0~100%
	3	Blue	000 ⇔ 255	0~100%
	4	Color Macros (Overrides CH 1~3)	000 ⇔ 015 016 ⇔ 255	No function Color Macros
	5	Speed (When CH.6 is between 032~223)	000 ⇔ 255	0~100%
		Strobe	000 ⇔ 015 016 ⇔ 255	No function Slow~fast
	6	Mode	000 ⇔ 031	RGB mode
			032 ⇔ 063	Pulse effect 0%~100%
			064 ⇔ 095	Pulse effect 100%~0%
			096 ⇔ 127	Pulse effect 100%~0%~100%
			128 ⇔ 159	Auto fade transition
			160 ⇔ 191	Auto snap transition (3 colors)
			192 ⇔ 223	Auto snap transition (7 colors)
	224 ⇔ 255	Sound triggering mode		
	7	Dimmer	000 ⇔ 255	0~100%

3-CH Mode	Channel	Function	Value	Setting
	1	Red	000 ⇔ 255	0~100%
	2	Green	000 ⇔ 255	0~100%
	3	Blue	000 ⇔ 255	0~100%

## 5. TECHNICAL INFORMATION

### General Maintenance

Dust build-up reduces light output performance and can cause overheating. This can lead to reduction of the light source's life and mechanical wear. To maintain optimum performance and minimize wear, you should clean your lighting fixtures at least twice a month. However, be aware that use and environmental conditions could be contributing factors to increase the cleaning frequency.

To clean this fixture, follow the instructions below:

- Unplug the fixture from power.
- Wait until the fixture is cold.
- Use a vacuum (or dry compressed air) and a soft brush to remove dust collected on the external surface and vents.
- Clean the LED transparent cover with a mild soap solution, ammonia-free glass cleaner, or isopropyl alcohol.
- Apply the solution directly to a soft, lint-free cotton cloth or a lens cleaning tissue.
- Softly wipe any dirt or grime to the outside edges of the LED transparent cover.
- Gently polish the transparent LED cover until it is free of haze and lint.



**Always dry the transparent LED cover carefully after cleaning.**

## 6. TECHNICAL SPECIFICATIONS

<b>Dimensions and Weight</b>	<b>Length</b>	<b>Width</b>	<b>Height</b>	<b>Weight</b>
	9.7 in (246 mm)	11.1 in (282 mm)	2.5 in (64 mm)	2.8 lbs (1.3 kg)
<b>Note:</b> Dimensions in inches rounded to the nearest decimal digit.				
<b>Power</b>	<b>Power Supply Type</b>	<b>Range</b>	<b>Voltage Selection</b>	
	Switching (internal)	100~240 V, 50/60 Hz	Auto-ranging	
	<b>Parameter</b>	<b>120 V, 60 Hz</b>	<b>230 V, 50 Hz</b>	
	Power	32 W	36 W	
	Operating current	0.28 A	0.16 A	
<b>Power I/O</b>	<b>Power I/O</b>	<b>US/Worldwide</b>	<b>UK/Europe</b>	
	Power input connector	IEC	IEC	
	Power output connector	Edison	IEC	
	Power Cord plug	Edison (US)	Local plug	
<b>Light Source</b>	<b>Type</b>	<b>Power</b>	<b>Lifespan</b>	
	LED	¼ W	100,000 hours	
	<b>Color</b>	<b>Quantity</b>	<b>Current</b>	
<b>Photo Optic</b>	Red	60	20 mA	
	Green	60	20 mA	
	Blue	60	20 mA	
	<b>Parameter</b>	<b>Value</b>		
Illuminance @ 1 m Illuminance @ 2 m Beam angle Field angle	3,640 lux 1,241 lux 14° 23°			
<b>Thermal</b>	<b>Maximum External Temp.</b>	<b>Cooling System</b>		
	104° F (40° C)	Convection		
<b>DMX</b>	<b>I/O Connectors</b>	<b>Connector Type</b>	<b>Channel Range</b>	
	3- pin XLR	Sockets	3, 7	
<b>Ordering</b>	<b>Product Name</b>	<b>Item Code</b>	<b>Item Number</b>	
	SlimPAR™ 64	03030271	SLIMPAR64	



UL 1573  
 CSA C22.2 No. 166  
 E113093

---

## Returns

Send the merchandise prepaid, in the original box, and with its original packing and accessories. CHAUVET® will not issue call tags.

Call CHAUVET® and request a Return Merchandise Authorization (RMA) number before shipping the fixture. Be prepared to provide the model number, serial number, and a brief description of the cause for the return.

The user must clearly label the package with a Return Merchandise Authorization (RMA) number. CHAUVET® will refuse any product returned without an RMA number.



**DO NOT write the RMA number directly on the box. Instead, write it on a properly affixed label.**

Once you have received the RMA number, please include the following information on a piece of paper inside the box:

- Your name
- Your address
- Your phone number
- The RMA number
- A brief description of the problem

Be sure to pack the fixture properly. Any shipping damage resulting from inadequate packaging will be the customer's responsibility. FedEx packing or double-boxing are recommended.



**CHAUVET® reserves the right to use its own discretion to repair or replace returned product(s).**

## Claims

The carrier is responsible for any damage incurred during shipping to this product or any part that shipped with it. Therefore, if the received merchandise appears to have damages caused during shipping, the customer must submit the damage report and any related claims with the carrier, not CHAUVET®. The customer must submit the report upon reception of the damaged merchandise. Failure to do so in a timely manner may invalidate the customer's claim with the carrier.

For other issues such as missing components or parts, damage not related to shipping, or concealed damage, the customer must make claims to CHAUVET® within 7 days of receiving the merchandise.

## Contact Us

### World Headquarters

CHAUVET®

#### General Information

Address: 5200 NW 108th Avenue  
Sunrise, FL 33351  
Voice: (954) 929-1115  
Fax: (954) 929-5560  
Toll free: (800) 762-1084

#### Technical Support

Voice: (954) 929-1115 (Press 4)  
Fax: (954) 756-8015  
Email: [tech@chauvetlighting.com](mailto:tech@chauvetlighting.com)

#### World Wide Web

[www.chauvetlighting.com](http://www.chauvetlighting.com)

### United Kingdom & Ireland

CHAUVET® Europe Ltd.

#### General Information

Address: Unit 1C  
Brookhill Road Industrial Estate  
Pinxton, Nottingham, UK  
NG16 6NT  
Voice: +44 (0)1773 511115  
Fax: +44 (0)1773 511110

#### Technical Support

Email: [uktech@chauvetlighting.com](mailto:uktech@chauvetlighting.com)

#### World Wide Web

[www.chauvetlighting.co.uk](http://www.chauvetlighting.co.uk)