

Roth™

*"I think cinema, movies, and magic have always been closely associated.
The very earliest people who made film were magicians."*

- Francis Ford Coppola

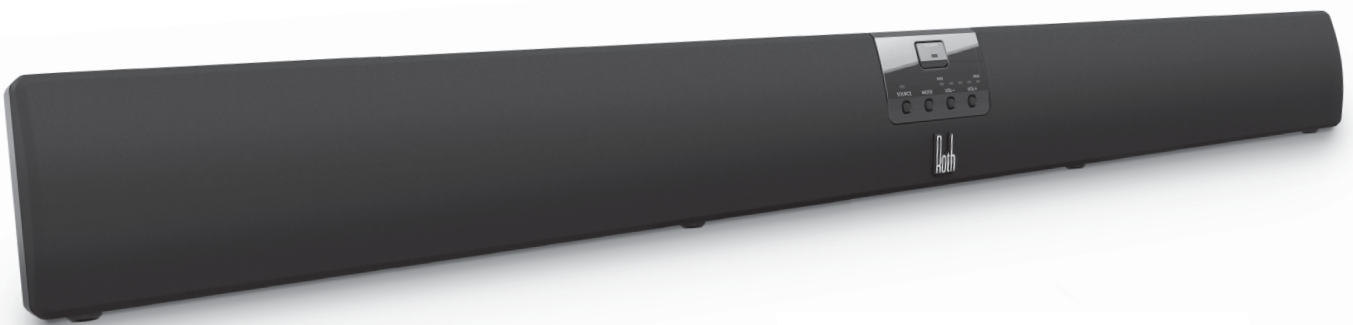

SUB ZERO II

TV Soundbar with Bluetooth APT-X

“Turn it up.”

SUB ZERO II

TV Soundbar with Bluetooth APT-X

CONTENTS

Key features	3
Important safety instructions	4-5
Supplied parts and accessories	6
Getting started	7
Wall mounting	8
Setup instructions (hookup guide)	9
Controls and functions	10-11
Hookup diagram	12
Trouble Shooting	13
Specifications	14



Please read these instructions carefully – we're using some quite complex technology and there may be a few changes to your current system set-up that you'll have to make to get the best performance possible.

Thank you...

...for choosing the Roth Audio Sub Zero II Soundbar.

Turn It Up.

Key Features

The Sub Zero II is designed to provide a high quality alternative to the loudspeakers in your flat-panel TV. To this end it has analogue inputs, an optical (digital) input and a Bluetooth APT-X input. The Bluetooth input allows you to stream music content direct from your mobile, laptop or tablet wirelessly, straight to the Sub Zero II. The Sub Zero II is designed to mount either on a desktop or on a wall with the supplied wall mount kit.

The Sub Zero II is best used with TV's from 32" up to 47" where its compact size and styling should unobtrusively complement your TV and the room décor.

Advanced Technologies in the Sub Zero II

Wider Sound Stage: The Sub Zero II features a 2.1 acoustic design utilising 2x 2.5 inch base drivers, 2x 2.5 inch broadband drivers and 2x passive membranes. Allied with the Roth MA DSP, it provides for 3x DSP presets of Movie, Music and Voice, each tailored to provide what we believe to be the best possible performance in each programme category.

The inputs available on the Sub Zero II should accommodate all TVs currently available, with analogue (RAC pair and 3.5mm stereo inputs), optical (Toslink/Stereo) input and Bluetooth APT-X (for wireless connectivity).

“The directing of a picture involves coming out of your individual loneliness and taking a controlling part in putting together a small world. A picture is made. You put a frame around it and move on. And one day you die. That is all there is to it.”

- John Huston

SUB ZERO II

TV Soundbar with Bluetooth APT-X

READ BEFORE USING THE SUB ZERO II SOUNDBAR

FOLLOW ALL WARNINGS AND INSTRUCTIONS MARKED ON THE SUB ZERO II SOUNDBAR.

1. Do not use this soundbar near water.
2. Clean only with a dry cloth.
3. Do not block any ventilation openings. Install in accordance with the instructions in this user guide.
4. Do not install near any heat sources such as radiators, stoves or other apparatus [including amplifiers] that produce heat.
5. Do not try to bypass the polarized or grounding type plug. A polarized plug has two blades with one wider than the other. A grounding type plug has two blades and a third grounding prong. The wide blade or the third prong is provided for your safety. If the provided plug does not fit into your outlet, consult an electrician for replacement of the obsolete outlet.
6. Unplug the soundbar from the mains supply during lightning storms or when unused for long periods of time.
7. Refer all servicing to qualified service personnel. Servicing is required when the soundbar has been damaged in any way, such as if the power-supply cord or plug is damaged, liquid has been spilled or objects have fallen into the soundbar, or the soundbar has been exposed to rain or moisture, does not operate normally, or has been dropped.
8. The system is designed to comply with the recommended safety standards for tilt and stability. Do not apply excessive pulling force to the front, or top, of the cabinet which could cause the soundbar to overturn resulting in soundbar damage and/or personal injury.
9. Follow instructions for wall, shelf or ceiling mounting as recommended in this user guide.

POWER SOURCES

This audio system is designed to operate on 230 volts 50Hz, AC current. The main plug is used as the disconnect device and should remain readily accessible. To prevent electric shock, do not use the soundbar's mains cable with an extension cord, receptacle, or other outlet unless the blades and ground terminal can be fully inserted to prevent blade exposure. Never connect the audio system to 60 Hz DC, or anything other than the specified voltage.

DISPOSAL

In the EU, electronic devices cannot be disposed of with regular household waste. Please use the return or collections systems of the retailer from whom you purchased the soundbar. Please dispose of batteries in an environmentally friendly manner. Do not dispose of batteries with regular household waste. Please use the return or collections systems of the retailer from whom you purchased the soundbar.



The exclamation point within an equilateral triangle, is intended to alert the user to the presence of important operating and maintenance (servicing) instructions in the literature accompanying the appliance.



The lightning flash with arrowhead symbol, within an equilateral triangle, is intended to alert the user to the presence of uninsulated "dangerous voltage" within the product's enclosure that may be of a sufficient magnitude to constitute a risk of electric shock to a person.



CAUTION

Never remove the back covers of the soundbar as this can expose you to very high voltages and other hazards. If the system does not operate properly, unplug the audio system and call your authorised dealer or service centre for advice. Adjust only those controls that are covered in the instructions.

WARNING

To reduce the risk of fire or electric shock, do not expose this soundbar to rain or moisture.

The system should not be exposed to dripping or splashing and objects filled with liquids, such as vases, should not be placed on the system.

This soundbar should only be connected to a mains socket outlet with a protective earthing connection.

ELECTRICAL INFORMATION

This system is fitted with a BS1363/A 13 amp plug. If it is not suitable for your supply sockets it must be removed and replaced with an appropriate plug. If the plug becomes damaged and/or needs to be replaced please follow the wiring instructions below. The plug removed must be disposed of immediately. It must not be plugged into a supply socket as this will be an electrical hazard. If the fuse needs to be replaced it must be of the same rating and ASTA approved to BS1362. If the plug is changed, a fuse of the appropriate rating must be fitted in the plug, adapter or at the distribution board. If the fuse in a moulded plug is replaced, the fuse cover must be refitted before the appliance can be used.



Proper disposal of this product. This label indicates that, in the EU, electronic devices cannot be disposed of with regular household waste. Please use the return or collections systems of your municipality or contact the seller where you purchased this product

WIRING INSTRUCTIONS

Follow the appropriate wiring instructions given below. In both cases ensure that the outer sheath of the cable is firmly held by the cable clamp.

2 - CORE PLUG

 This symbol indicates that this 2-core appliance is Class II and does not require an earth connection.

The wire coloured blue must be connected to the terminal marked with the letter N or coloured black. The wire coloured brown must be connected to the terminal marked with the letter L or coloured red.

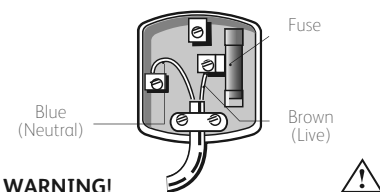

WARNING!
Do not connect either wire to the earth terminal.

3 - CORE PLUG

The wire coloured green and yellow must be connected to the terminal marked with the letter E, or by the earth symbol  or coloured green or green and yellow.

The wire coloured blue must be connected to the terminal marked with the letter N or coloured black. The wire coloured brown must be connected to the terminal marked with the letter L or coloured red.

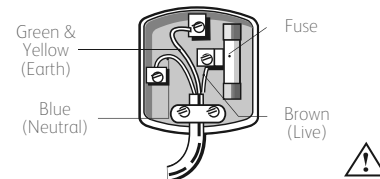

WARNING! This appliance must be earthed.

The exclamation point within an equilateral triangle is intended to alert the user to the presence of important operating and maintenance (servicing) instructions in the literature accompanying the appliance.

The lightning flash with arrowhead symbol, within an equilateral triangle, is intended to alert the user to the presence of uninsulated "dangerous voltage" within the soundbar's enclosure that may be of a sufficient magnitude to constitute a risk of electric shock.

CAUTION To prevent electric shock do not plug a cable into a wall outlet, extension cord, or other receptacle unless the metal blades can be fully inserted to prevent blade exposure.

SUB ZERO II

TV Soundbar with Bluetooth APT-X

What's In The Box

SUB ZERO II SOUNDBAR



SUB ZERO II REMOTE CONTROL



ACCESSORIES

- RCA Hookup Cable
- Wall Mounting Kit
- User Manual

Battery Installation

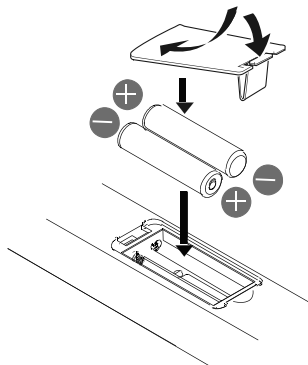

Caution

- Do not insert battery with '+' and '-' polarities reversed as this may cause the battery to swell or rupture resulting in leakage.
- Remove the battery if the remote control is not going to be used for an extended period of time.
- Do not put the battery in the general household rubbish. Dispose of the battery according to applicable laws.

Getting Started

Determine how you want to set up your Sub Zero II Soundbar.

The following figures show 2 typical installation styles. One is the Table Top style and the other is the Wall Mount style.



Table Top Style

You can mount the Sub Zero II on a cabinet that is properly designed for a TV.

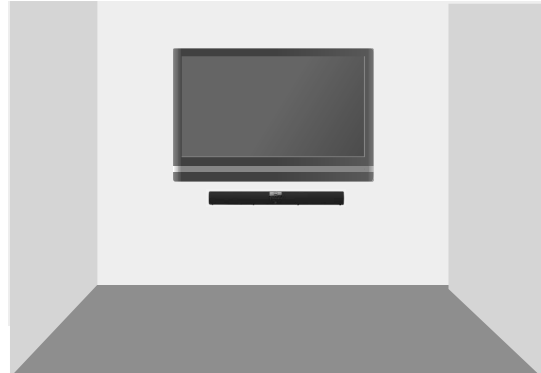

Wall Mount Style

You can mount the Sub Zero II on a wall by using the supplied hardware kit. The input jacks and power cord are designed to allow a flush mount.

Think About Location

Select an area where sunlight will not fall directly on the soundbar. Also, be sure that the location selected allows a free flow of air to and from the soundbar and power supply. In order to prevent an internal temperature increase, maintain the following space requirements.

Sub Zero II Soundbar

Top / Bottom / Back: No clearance required - can be flush mounted.

Left / Right: At least 6" (150 mm) clearance required.

Front: Open between the Sub Zero II and the listeners.

SUB ZERO II

TV Soundbar with Bluetooth APT-X

Wall Mounting

Determine how you want to set up your Sub Zero II Soundbar.

The Sub Zero II Soundbar comes with a wall mounting kit to be used with a wall mounted TV. The input jacks and power cord are designed to allow a flush mount.

Follow these steps to mount the Sub Zero II Soundbar on a wall:

1. Measure the width of the TV - the Sub Zero II should be mounted so it is centered with the TV. Divide the TV width measurement by 2 - that will be the centerline distance from the edges of the TV.
2. If the Sub Zero II is to be mounted below the TV, measure from the TV edge to the centerline distance on the open wall below the TV. Mark the distance with a pencil 38mm or more below the bottom of the TV.
3. Make a pencil mark 230 mm on each side of the centerline. Make sure the mark is the same distance down from the TV on each side.
4. Drill a hole in the wall at either of the two pencil marks.
5. Hammer the 2 wall mount anchors into the holes - the anchors should be flush with the wall.
6. Now, using a Phillips screwdriver, screw the wall brackets in place with the screws going into the anchors.
7. Tilting the bottom of the Sub Zero II slightly away from the wall, guide the brackets into the matching holes on the back of Sub Zero II. The Sub Zero II is now securely wall mounted.

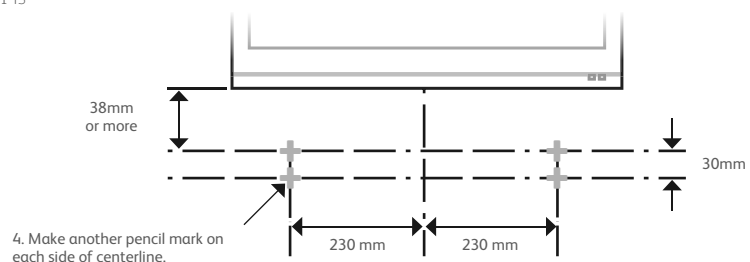
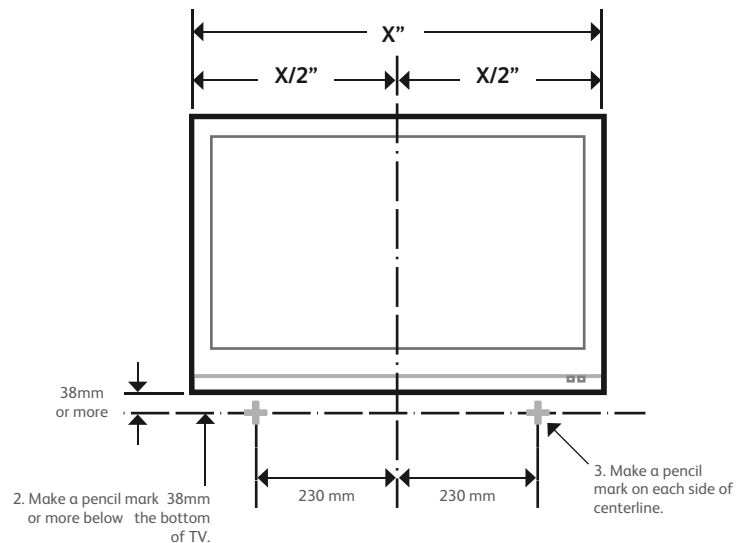

NOTES

The supplied mounting kit can be used for typical drywall construction. Mounting to wood, concrete, brick or other types of wall construction will require different hardware. Roth AV recommends seeking professional assistance for such installations. The instructions on this page and the supplied wall mount kit are only for the vertical wall mount. Professional assistance is required for other mounting or installation orientations (e.g., horizontal, tilted).

Setup Instructions

1. If your TV has a headphone output, plug the supplied 3.5 mm mini stereo cable into the headphone jack output of your TV and the other end goes to the input jack (Input 2) on the back of your Sub Zero II (shown below).
2. If your TV does not have a headphone output and you are using a set top box, plug one end of the included RCA cable into the audio outputs of your set top box and the other end into input 1 on the back of your Sub Zero II. The Sub Zero II remote control and the control buttons on the front panel of the Sub Zero II will always function no matter what the audio input source is.

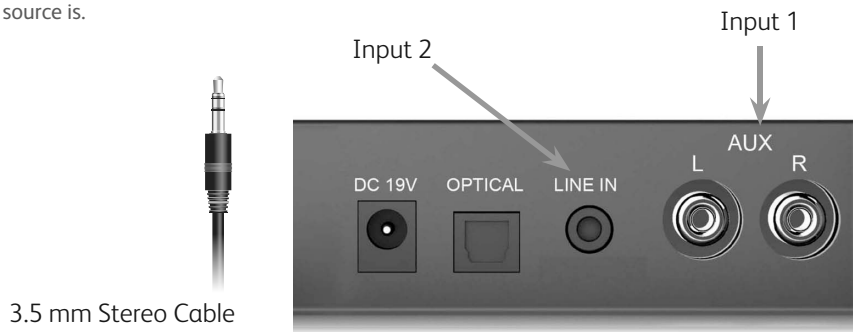

[Note] Some TV's do not have a headphone output but do have Audio outputs with RCA jacks. You can connect them to input 2 by using the RCA cable. This will also work fine except that the Sub Zero II volume must now be adjusted using the Sub Zero II remote.

3. Input 3 is an Optical Input. If your TV does not have a headphone output, use this input to connect with the set-top-box by using an Optical Input cable (not included).

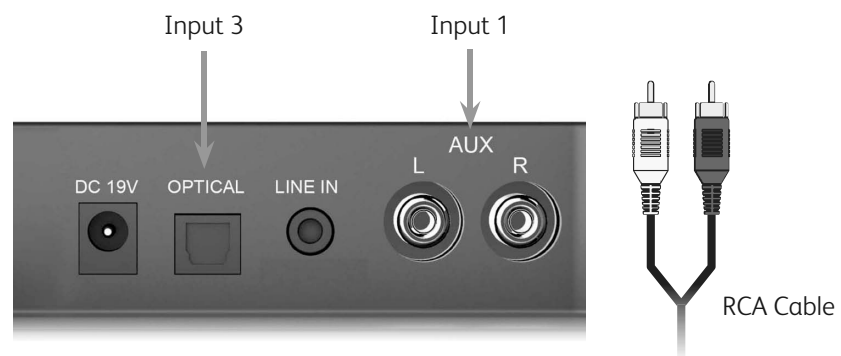

SUB ZERO II

TV Soundbar with Bluetooth APT-X

Controls and Functions

The controls and functions of the Sub Zero II are explained below.

Front Panel Controls / LED Indicators

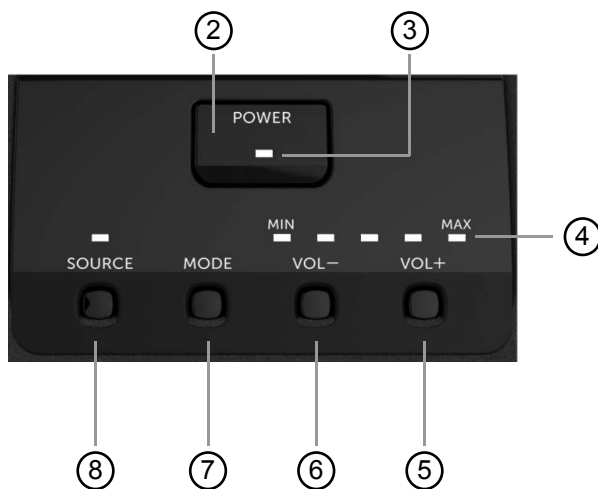

1. REMOTE CONTROL Sensor Area

Point your remote control at this area when you use the remote control.

2. POWER Button

Plug the power cord into the AC outlet. The Sub Zero II goes to the standby mode. Press this button to turn the Sub Zero II on; this Power indicator will turn off to indicate the Sub Zero II is on. This indicator will remain on as long as an input signal is active. If the input becomes inactive the Sub Zero II will change to standby mode to conserve power and this indicator will illuminate.

3. POWER ON indicator

Plug the power cord into the AC outlet. The Sub Zero II goes to the standby mode. Press this button to turn the Sub Zero II on; this Power indicator will turn off to indicate the Sub Zero II is on. This indicator will remain on as long as an input signal is active. If the input becomes inactive the Sub Zero II will change to standby mode to conserve power and this indicator will illuminate.

4. MAIN VOLUME level indicator

The indicator shows the level of the main volume or Soundbar volume when you use the VOLUME + or VOLUME - Button respectively. This indicator will turn off a few seconds from adjusting the volume.

5. VOLUME + Button

Adjust the main volume up respectively.

6. VOLUME - Button

Adjust the main volume down respectively.

7. Mode Button

Press this button to select DSP mode for Movies or Music. Choose whichever mode sounds right to you - people have different tastes so we do not assume that just because we like to watch movies with the Movie mode switched-on, you will too.

8. SOURCE Button

Press this button to select INPUT 1, INPUT 2, INPUT 3 or INPUT 4.

INPUT 1 - RCA

Connection type-RCA. Use this input to connect with your external device (Blu-ray players, DVD players, CD players, MP3 players, or Home video Game Systems

INPUT 2 - 3.5MM LINE INPUT

Connection type-3.5 mm stereo cable. If your TV has a headphone output, this is a primary input to use by using the supplied 3.5 mm mini stereo cable.

INPUT 3 - OPTICAL INPUT

Connection type- Optical Input . If your TV does not have a headphone output, use the input to connect with the set-top-box by using the Optical INPUT cable (not included).

INPUT 4 / BLUETOOTH APT-X INPUT

To pair with your Bluetooth device, switch to this input and there will be an audible tone from the soundbar. 'Search' for the ID 'SUBZERO' and when found press 'PAIR' on your device. There should be a second audible tone to confirm pairing and away you go!

Remote Control

The controls and functions of the Sub Zero II Remote Control are explained below.

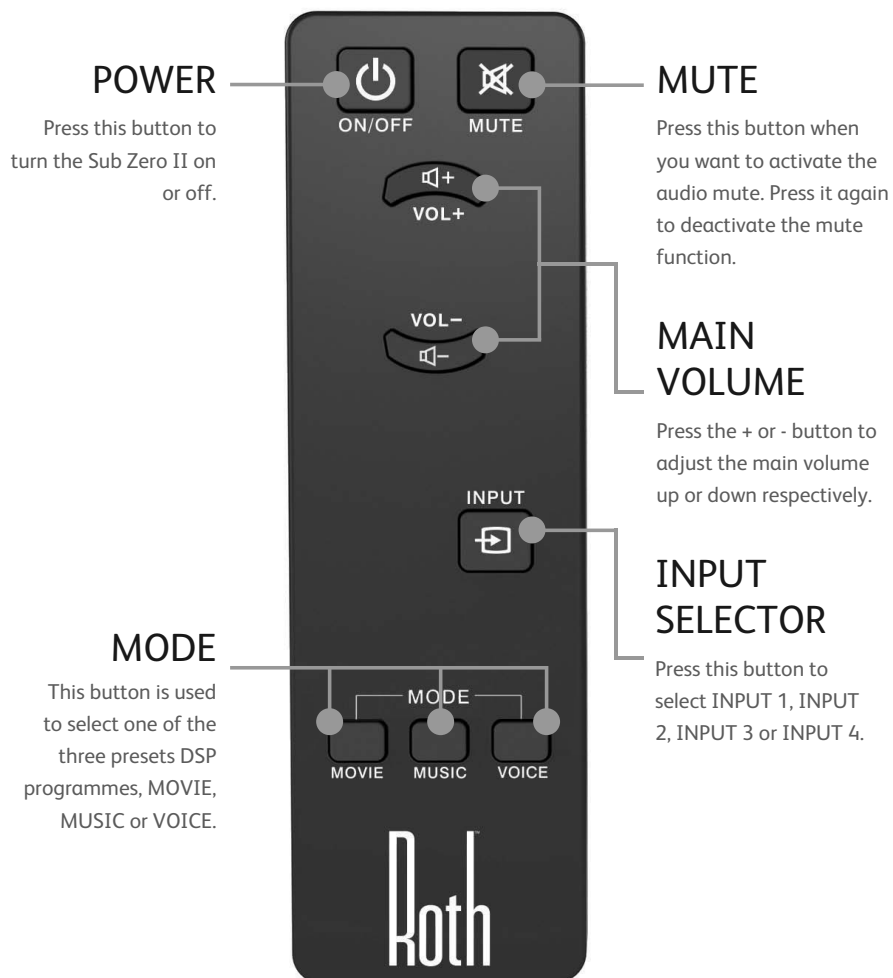

Remote Control

Hookup Diagram

TV Audio Hookup - Case 1

If your TV has a headphone output, plug a 3.5 mm mini stereo cable into the headphone output from your TV and plug the other end to the Input 2 jack on the back of your Sub Zero II.

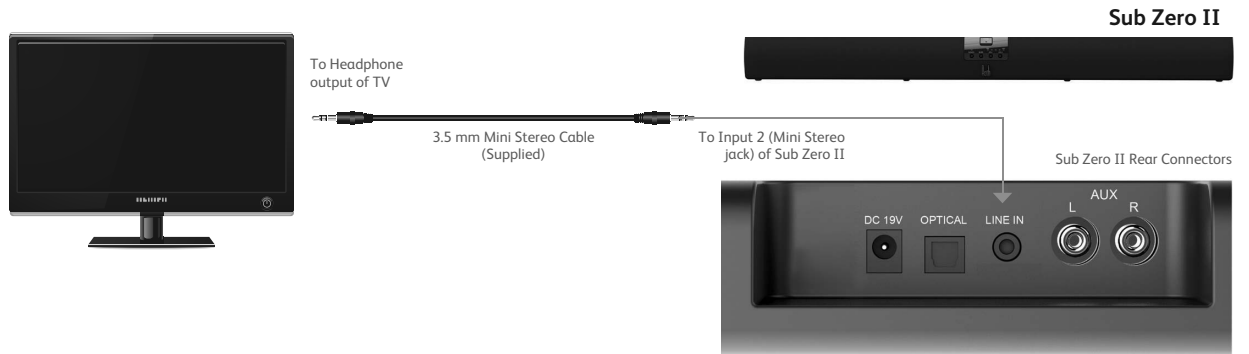

TV Audio Hookup - Case 2

If your TV does not have a headphone output and you are using a set top box, plug one end of an RCA cable into the outputs from your top box and plug the other end into Input 1 on the back of your Sub Zero II.

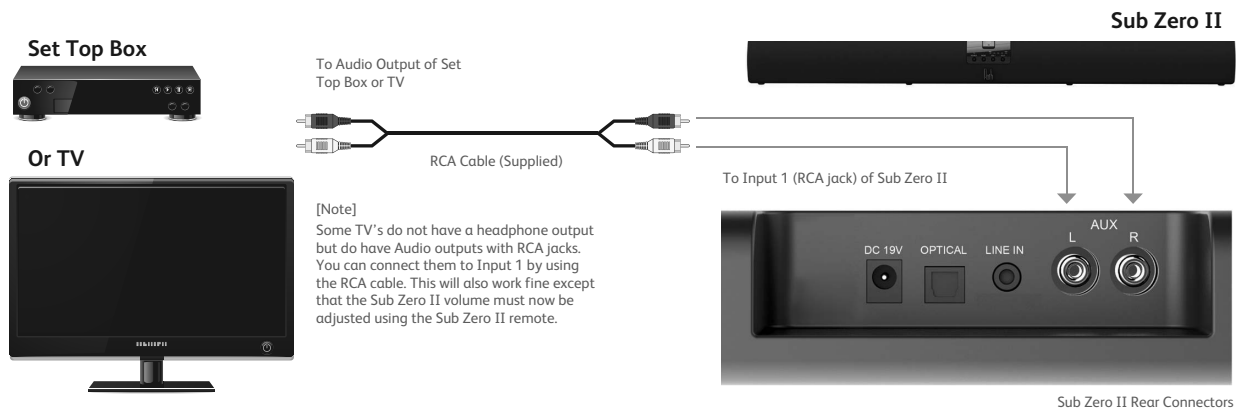

Audio Hookup - Other Device

The input 3 can be attached to Blu-ray, DVD or CD players or Home Video Game systems.

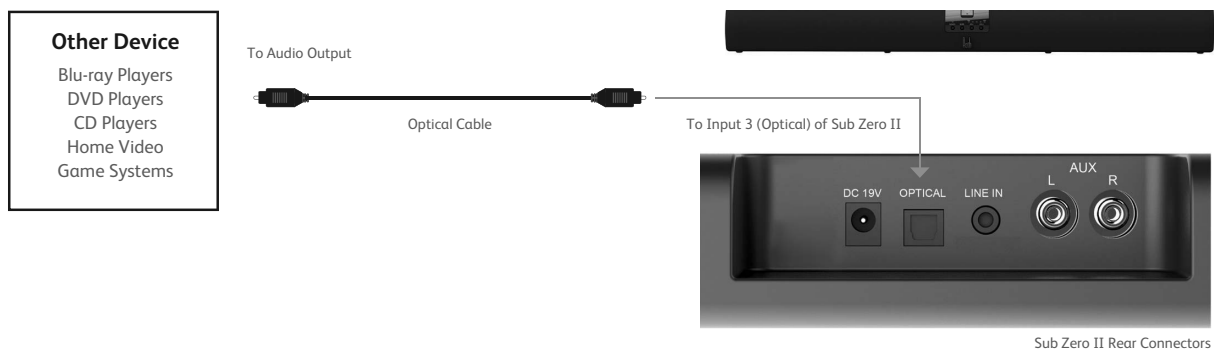

Trouble Shooting

If you encounter problems when using the Sub Zero II Soundbar, check the following points before requesting service.

In order to keep the warranty valid, please DO NOT try to repair the system yourself.

NOTE: DUE TO EEC REGULATIONS THIS PRODUCT WILL SWITCH TO STANDBY MODE AS FOLLOWS

The Subzero II switches to standby mode in the following situation:

- The device is idle for 30mins when powered by AC supply;
- The L/R Audio in or 3.5mm jack is disconnected or when there is no input signal or the input signal is too low.

If using the 3.5mm jack or L/R audio input to Subzero II, we recommend to default the output volume at 50% or above on the external devices to ensure that it does not automatically go into standby mode.

1. No power

- 1-1. Make sure power cords are securely connected to the AC output.
- 1-2. Make sure that there is power at the AC output.
- 1-3. Press the power button on the remote control or the front of the Sub Zero II.

2. No sound

- 2-1. Press the Volume + (Up) button on the remote control or the front of the Sub Zero II.
- 2-2. Make sure that you selected correct input (Input 1, Input 2, or Input 3).
- 2-3. Press MUTE on the remote to make sure the Sub Zero II is not muted.
- 2-4. Make sure audio cables are securely connected at the terminals of the Sub Zero II and the external devices.

3. Buzzing or humming noise

- 3-1. Make sure audio cables are securely connected at the terminals of the Sub Zero II and the external devices.
- 3-2. Test on an alternate device or replace the audio cable.
- 3-3. Test the device and cable on an alternate input on the Sub Zero II.

4. The remote control does not work

- 4-1. Aim the remote control directly at the sensor on the front of the Sub Zero II.
- 4-2. Reduce the distance between the remote control and the Sub Zero II.
- 4-3. Make sure that the battery is inserted with its polarities (+/- signs) aligned as indicated.
- 4-4. Replace the battery.

5. The buttons on both the remote control and front panel do not work

- 5-1. Unplug the power cord from the AC output, and plug back in after a few seconds.

SUB ZERO II

TV Soundbar with Bluetooth APT-X

Sub Zero II Specifications

Input Sources

- Bluetooth
- Line-in (3.5mm)
- Optical
- Aux (RCA)

Bluetooth

- A2DP audio using either SBC & Apt-x decoders

Line-in

- 3.5mm stereo mini-jack
- 500 mV RMS full scale input

Aux-in

- RCA input
- 500 mV or 2V RMS full scale input TBD

Optical

- SPDIF format
- Toslink compatible
- Stereo only
- Up to 96 KHz sample rate at up to 24 bit PCM data

Amplifiers

- Class-D power-stages.
- 2x10W capability@<10% THD+N
- 2x20W capability@<10% THD+N

Signal Processing

- NCPA 110P AE Engine DSP

AC Power

- External 19V 3.42A (65W) 220/110 AC input

Keys

- Power
- Source
- Vol+
- Vol-
- Mode

Power

- Source
- Vol+
- Vol-
- Mode

Indicators

There are 7 LEDs on the front panel as follows:

1. Power LED
 - Standby, LED is GREEN
 - Normal operation, LED is PURPLE
2. Source LED (RGB LED)
 - Line-in, LED is RED
 - AUX in, LED is GREEN
 - Optical operation, LED is WHITE
 - Bluetooth operation, LED is BLUE
3. 5 x Volume LEDs (BLUE)
 - LEDs will display the current volume level (20 steps)
 - Volume is at zero all LEDs will flash to indicate muting

General

- Operating Temperature: 5°C - 40°C (32°F ~ 104°F)
- Power Requirements: AC 230 - 240V ~ 50Hz
- Power Consumption: 65W

All specifications, features and dimensions are subject to change without notice.

“A film is - or should be - more like music than like fiction. It should be a progression of moods and feelings. The theme, what’s behind the emotion, the meaning, all that comes later. ”

- Stanley Kubrick

Notes





SERVICE

Please contact your local authorised dealer or reseller.

Email: support@rothaudio.co.uk

In accordance with our policy of continuous development, we reserve the right to change specifications without notice. Photographs are for illustration only and actual product may vary. E&OE.

Roth

facebook

Find us on Facebook.
Just search for Roth AV.

rothaudio.co.uk