

HD CCTV DVR USER MANUAL

■ 2MP ~ 5MP Video Recording

Please read instructions thoroughly before operation and retain it for future reference.

For the actual display & operation, please refer to your DVR in hand.

Complete user manual download: www.surveillance-download.com/user/z404.swf

IMPORTANT SAFEGUARD



CAUTION



RISK OF ELECTRIC SHOCK

CAUTION:

To reduce the risk of electric shock, do not expose this apparatus to rain or moisture. Only operate this apparatus from the type of power source indicated on the label. The company shall not be liable for any damages arising out of any improper use, even if we have been advised of the possibility of such damages.



The lightning flash with arrowhead symbol, within an equilateral triangle, is intended to alert the user to the presence of uninsulated "dangerous voltage" within the product's enclosure that may be of sufficient magnitude to constitute a risk of electric shock to persons.



This exclamation point within an equilateral triangle is intended to alert the user to the presence of important operating and maintenance (servicing) instructions in the literature accompanying the appliance.



All lead-free products offered by the company comply with the requirements of the European law on the Restriction of Hazardous Substances (RoHS) directive, which means our manufacture processes and products are strictly "lead-free" and without the hazardous substances cited in the directive.



The crossed-out wheeled bin mark symbolizes that within the European Union the product must be collected separately at the product end-of-life. This applies to your product and any peripherals marked with this symbol. Do not dispose of these products as unsorted municipal waste. Contact your local dealer for procedures for recycling this equipment.



This apparatus is manufactured to comply with the radio interference requirements.

Federal Communications Commission Interference Statement

This equipment has been tested and found to comply with the limits for a Class A digital device, pursuant to Part 15 of the FCC Rules. These limits are designed to provide reasonable protection against harmful interference when the equipment is operated in a commercial environment. This equipment generates, uses, and can radiate radio frequency energy and, if not installed and used in accordance with the instruction manual, may cause harmful interference to radio communications. Operation of this equipment in a residential area is likely to cause harmful interference in which case the user will be required to correct the interference at his own expense.

Trademark Acknowledgements



(EagleEyes) - The trademark application is filed and under process in the U.S. and other countries.

iPhone®, iPad® and iOS® are the registered trademark of Apple Inc., and Apple holds the intellectual property rights to the iPhone, iPad and iOS content.

Microsoft®, Windows®, Internet Explorer®, Google Chrome™ & QuickTime® mentioned in this document are the registered trademarks of their respective holders.

Disclaimer

The information in this manual was current when released. We reserve the right to revise or remove any content in this manual at any time. We do not warrant or assume any legal liability or responsibility for the accuracy, completeness, or usefulness of this manual. For the actual display & operation, please refer to your DVR in hand. The content of this manual is subject to change without notice.

Grounding

This is a Safety Class 1 Product (provided with a protective earthing ground incorporated in the power cord). The mains plug shall only be inserted in a socket outlet provided with a protective earth contact. Any interruption of the protective conductor inside or outside of the instrument is likely to make the instrument dangerous. Intentional interruption is prohibited.

Water & Moisture

Do not expose this product to dripping or splashing and that no objects filled with liquids, such as vases, shall be placed on the product.

MPEG4 Licensing

THIS PRODUCT IS LICENSED UNDER THE MPEG-4 VISUAL PATENT PORTFOLIO LICENSE FOR THE PERSONAL AND NON-COMMERCIAL USE OF A CONSUMER FOR (i) ENCODING VIDEO IN COMPLIANCE WITH THE MPEG-4 VISUAL STANDARD ("MPEG-4 VIDEO") AND/OR (ii) DECODING MPEG-4 VIDEO THAT WAS ENCODED BY A CONSUMER ENGAGED IN A PERSONAL AND NON-COMMERCIAL ACTIVITY AND/OR WAS OBTAINED FROM A VIDEO PROVIDER LICENSED BY MPEG LA TO PROVIDE MPEG-4 VIDEO. NO LICENSE IS GRANTED OR SHALL BE IMPLIED FOR ANY OTHER USE. ADDITIONAL INFORMATION INCLUDING THAT RELATING TO PROMOTIONAL INTERNAL AND COMMERCIAL USES AND LICENSING MAY BE OBTAINED FROM MPEG LA, LLC. SEE [HTTP://WWW.MPEGLA.COM](http://www.mpegla.com).

GPL Licensing



This product contains codes which are developed by Third-Party-Companies and which are subject to the GNU General Public License ("GPL") or the GNU Lesser Public License ("LGPL").

The GPL Code used in this product is released without warranty and is subject to the copyright of the corresponding author.

Further source codes which are subject to the GPL-licenses are available upon request.

We are pleased to provide our modifications to the Linux Kernel, as well as a few new commands, and some tools to get you into the code. The codes are provided on the FTP site, and please download them from the following site or you can refer to your distributor:

<http://download.dvrtw.com.tw/GPL/DVR/GM8210/linux-3.3-fa.tgz>

TABLE OF CONTENTS

1. HARDWARE OVERVIEW	1
1.1 Package Content	1
1.2 Front Panel	1
1.3 Rear Panel	2
2. CONNECTION AND SETUP	4
2.1 SATA Hard Disk Installation	4
2.2 Camera Connection	6
2.2.1 Normal Camera	6
2.2.2 HD CCTV Camera Series	6
2.2.3 Other brand's speed dome camera	6
2.2.4 IP Camera	7
2.3 DVR Power On	7
3. FOR INITIAL USE	8
3.1 Setup Wizard	8
3.2 Clear Hard Disk	10
3.3 Change User Name and Password	11
4. USER INTERFACE	12
4.1 DVR Access	12
4.2 Live Page	12
4.2.1 DVR Status	12
4.2.2 Channel Status	13
4.2.3 Record-related Icons	13
4.3 Quick Menu Bar	13
4.4 Main Menu	14
5. FREQUENTLY-USED FUNCTIONS	15
5.1 Key Lock / Unlock	15
5.2 User Level Creation	15
5.3 PTZ Control	17
5.4 Playback	18
5.4.1 Playback Control	19
5.4.2 Event Search	19
5.4.3 Audio Playback	19
5.5 Video Backup	19
5.6 Video Playback on PC (.dv5)	20
5.6.1 Convert the file format to AVI	21
5.7 Digital Zoom	21
6. MAIN MENU	22
6.1 QUICK START	22
6.1.1 GENERAL	22
6.1.2 TIME SETUP	24
6.1.3 DAYLIGHT	24
6.1.4 EaZy	25
6.2 SYSTEM	25
6.2.1 ACCOUNT	25
6.2.2 TOOLS	26
6.2.3 SYSTEM INFO	27
6.2.4 ONLINE	29
6.2.5 BACKUP DATA	30

6.2.6 BACKUP LOG	32
6.3 EVENT INFORMATION	33
6.3.1 QUICK SEARCH	33
6.3.2 EVENT SEARCH	33
6.3.3 HDD INFO	34
6.3.4 EVENT LOG	34
6.4 ADVANCED CONFIG	35
6.4.1 CAMERA	35
6.4.2 DETECTION	36
6.4.3 ALERT	38
6.4.4 NETWORK	39
6.4.5 DISPLAY	40
6.4.6 RECORD	41
6.4.7 DEVICES	42
6.4.8 DCCS	43
6.4.9 IVS	43
6.4.10 NOTIFY	48
6.4.11 JOYSTICK	53
6.5 SCHEDULE SETTING	53
6.5.1 RECORD / DETECTION / ALARM IN / ALARM OUT / PUSH VIDEO / BUZZER	53
6.5.2 REGULAR REPORT	54
6.5.3 AUTO BACKUP	54
6.5.4 REGULAR REBOOT	56
7. REMOTE OPERATION	57
7.1 Web Browser	57
7.1.1 IVS Statistics	59
7.1.2 PTZ Panel	60
7.2 Mobile Devices	61
7.2.1 Prerequisites	61
7.2.2 Where to download	61
7.2.3 Manual Setup	61
APPENDIX 1 SPECIFICATIONS	63
APPENDIX 2 PUSH VIDEO CONFIGURATION	69
A2.1 Alarm Sensor Connection	69
A2.2 Configuration	70
APPENDIX 3 SET PUSH VIDEO	71
A3.1 Prerequisite	71
A3.2 Enable Push Video	72
A3.2.1 From iOS Mobile Device (iPhone / iPad)	72
A3.2.2 From Android Mobile Device	73
APPENDIX 4 COMPATIBLE USB FLASH DRIVE LIST	74
APPENDIX 5 COMPATIBLE SATA HDD LIST	75
APPENDIX 6 MAIN MENU STRUCTURE	76
APPENDIX 7 DVR BATTERY REPLACEMENT	78
APPENDIX 8 EAZY NETWORKING	79
A8.1 Via EagleEyes on iOS / Android Device	79
A8.2 Via Internet Explorer on PC / Laptop	84
A8.3 Cloud Icons	89

1. HARDWARE OVERVIEW

Note: The functions on the front panel and rear panel may vary, depending on the model you have.

1.1 Package Content

> Standard Package





- | | |
|---|--------------------------------------|
| <input type="checkbox"/> DVR | <input type="checkbox"/> HDD screws |
| <input type="checkbox"/> Adapter & power cord | <input type="checkbox"/> Quick Start |

> Optional Accessories

- | | |
|---|---|
| <input type="checkbox"/> I/O terminal block | <input type="checkbox"/> IR Remote Controller |
| <input type="checkbox"/> USB Mouse | |

1.2 Front Panel

1) LED Indicators

-  DVR is powered on.
-  The hard disk is reading or recording.
-  An alarm is triggered. *(For selected models only)*
-  Timer recording is on. *(For selected models only)*
-  Under playback status. *(For selected models only)*

2) CH1 ~ 16 / 1 ~ 8 / 1 ~ 4

Press the channel number buttons to select the channel to display.

3)

Press to show the 4 channel display mode.

4) SEQ

Press to display each channel in full screen one by one starting from CH1. When the last channel is displayed, it will repeat from CH1 again. To exit this mode, press **SEQ** again.

5) SLOW

In the playback mode, press to show slow playback.

6) ZOOM

Press to enlarge the picture of selected channel in the FRAME or FIELD recording mode.

7) PLAY

Press to playback the latest recorded data.

8) LIST (Event List Search)

Press to quickly search the recorded files by event types, or select **FULL** to show all the event logs.

To quickly search the time you want, select **QUICK SEARCH**. For details, please refer to "5.4.2 Event Search" at page 19.

9) ENTER

Press **ENTER** to confirm the setting.

10) MENU

Press **MENU** to enter the main menu.

11) **▲ (|| / PAUSE) / ▼ (■ / STOP) / ◀ (◀◀ / REW) / ▶ (▶▶ / FF)**

Press ▲ / ▼ / ◀ / ▶ to move up / down / left / right.

In the playback mode:

Press ▲ to pause playback.

Press ▼ to stop playback.

Press ▶ to fast forward.

Press ◀ to fast rewind.

12) **AUDIO (SLOW + ZOOM)**

Press **SLOW + ZOOM** to select live or playback audio from audio channel 1~4.

 Live audio from audio channel 1~4
(indicated in white).

 Playback audio from audio channel 1~4
(indicated in yellow).

 Audio channel unselected

13) **P.T.Z. (⊞ + SEQ)**

Press ⊞ + **SEQ** at the same time to enter / exit the PTZ control mode.

14) **USB port**

There are two USB ports on the front panel, one for connecting your USB mouse for mouse control, and the other one for connecting your USB flash drive for video backup.

Note: It's not allowed to have two USB mice or two USB flash drives connected on the front panel.

Note: For the compatible USB flash drive list, please refer to "APPENDIX 4 COMPATIBLE USB FLASH DRIVE LIST" at page 74.

1.3 Rear Panel

1) **VIDEO IN:** Connect to the video connector of a camera.

Note: The DVR will automatically detect the video system of the camera, please make sure that the cameras are properly connected to the DVR and power-supplied before the DVR is turned on.

2) **AUDIO IN**

Connect to the audio connector of a camera if the camera supports audio recording.

Note: To make a video backup with audio, make sure the camera which supports the audio function is connected to the video-in channel and audio-in channel. For example, the audio data from audio CH1 will be recorded with the video data from video CH1.

For 16CH models, the audio CH1 ~ CH4 are corresponding to video CH1 ~ CH4 respectively.

3) **AUDIO OUT**

Connect to a speaker with 1 mono audio output.

4) **HDMI**

Connect to the HDMI port of the monitor which supports HDMI video output.

Note: Dual video outputs via both VGA and HDMI ports are supported.

5) **VGA**

Connect to the VGA port of the monitor which supports VGA video output.

Note: Dual video outputs via both VGA and HDMI ports are supported.

6) **IR (For selected models only)**

Connect the IR receiver extension line for remote control.

7) **eSATA (For selected models only)**

This port is used to connect a storage device supporting eSATA interface; for instance, an external hard disk or a disk array.

Note: Please purchase a disk array supporting Linux system to ensure your DVR to work properly.

Note: If the disk array is not connected or detected well, check the mode of your disk array, or do a reset default on your disk array and try again.

8) External I/O (Alarm IN / Alarm Out / RS485) *(For selected models only)*

These ports are used to connect external devices (such as speed dome cameras or external alarm, etc).

9) LAN

Connect to Internet by LAN cable.

10) DC IN

Connect to the supplied adapter.

11) VIDEO OUT

Connect to a CRT monitor for main or call monitor output.

12)  Power Switch *(For selected models only)*

Switch to “—” to turn on the power, and “O” to turn off the power.

2. CONNECTION AND SETUP

Before the DVR is powered on, make sure you have installed a hard disk, connected at least one camera and a HDMI monitor. For details, please refer to the following sections.

Note: The DVR is designed to automatically detect the video system of the connected cameras (NTSC or PAL). To make sure the system detection is correct, please check if the cameras are connected to the DVR and power-supplied before the DVR is powered on.

2.1 SATA Hard Disk Installation

At least a hard disk is necessary for the recorder to save video footage, and firmware upgrade might be failed if there's no hard disk installed in this recorder.

Either of the following two types of hard disk installation is applicable for your DVR model. Please check the instructions below to see which installation method is the right one for your DVR to install a hard disk.

➤ Type 1

Note: Here takes an 8CH model as an example of how to connect a hard disk to your device. To know how many hard disks could be installed, please refer to the specifications of your device.

Step1: Remove the top cover, and find the hard disk connector and bracket in the device.

Step2: Get a compatible hard disk. With the PCB side facing down, insert the hard disk to one of the hard disk connector.

Note: To use a green hard disk, use **ONLY** the hard disk designed especially for surveillance to ensure the device works properly.

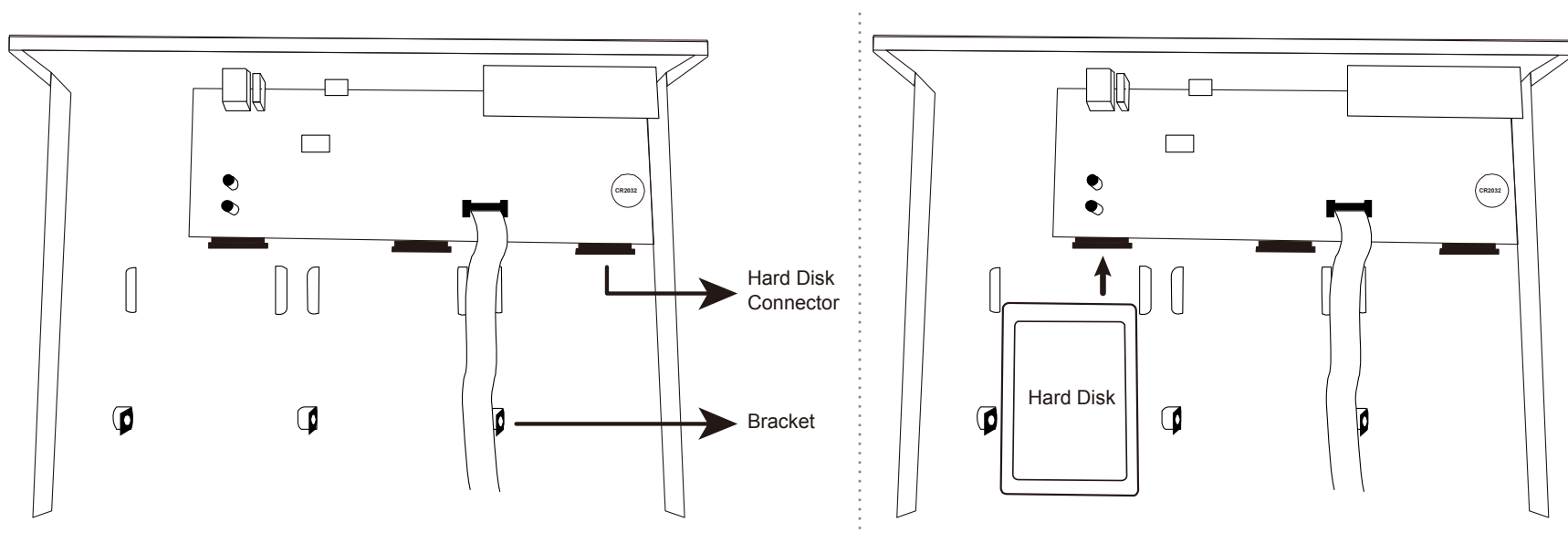

Step3: Fasten the hard disk to the bracket by securing the screw on the bracket.

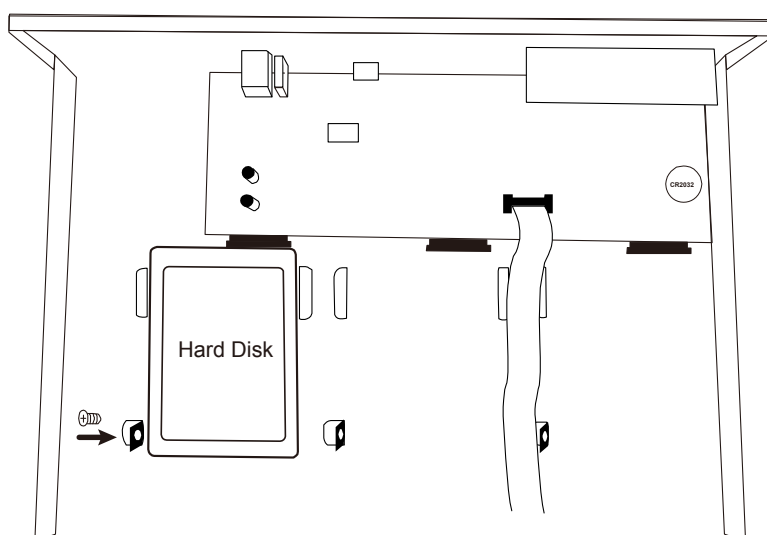

Step4: Replace the top cover and fasten the screws you loosened in Step1.

➤ **Type 2**

Note: Here takes an 8CH model as an example of how to connect a hard disk to your device. To know how many hard disks could be installed, please refer to the specifications of your device.

Step1: Remove the top cover, and find where to install a hard disk.

Step2: Get a compatible hard disk. With the PCB side facing down, find the screw holes on the DVR base, and place the hard disk in the DVR.

Note: To use a green hard disk, use **ONLY** the hard disk designed especially for surveillance to ensure the device works properly.

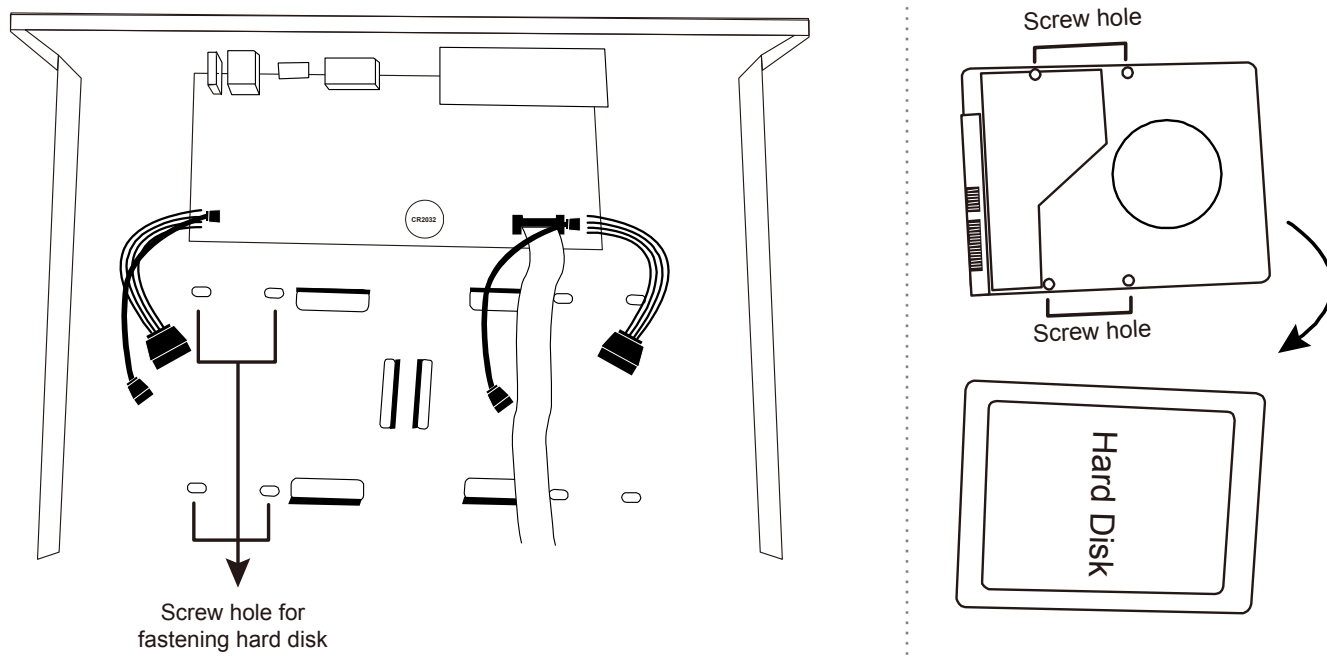

Step3: Align the screw holes on the DVR base and the hard disk. Then, fasten the hard disk o the DVR base with the supplied screws from the bottom side of the DVR.

Step4: Connect the data bus and power cable for the hard disk.

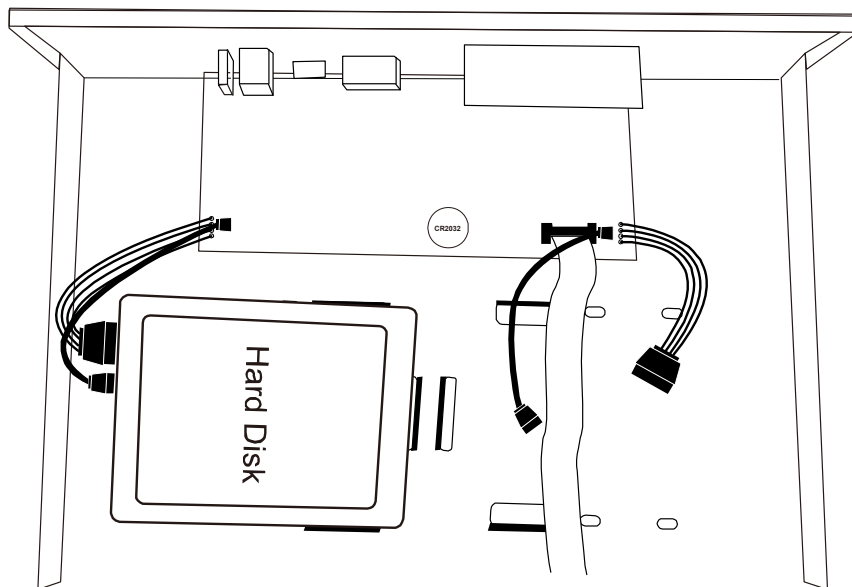

Step5: Replace the top cover and fasten the screws you loosened in Step1.

2.2 Camera Connection

Install the camera on the wall or ceiling based on your installation environment and camera type. For installation details, please refer to the user manual of your camera.

2.2.1 Normal Camera

- STEP 1: Connect the coaxial cable to the DVR.
- STEP 2: (Optional) Connect the audio cable to the DVR.
- STEP 3: Power on the camera and see if the live video shows.

2.2.2 HD CCTV Camera Series

- STEP 1: Connect the coaxial cable to the DVR.
- STEP 2: Power on the camera and see if the live video shows.
- STEP 3: On the DVR side, right click to show the main menu, and go to  (ADVANCED CONFIG) → **DCCS** → **OSD MENU** to configure the camera if needed.

ADVANCED CONFIG	
CAMERA	CH1 CH2 CH3 CH4
DETECTION	OSD MENU SETUP
ALERT	DCCS MENU SETUP
NETWORK	
DISPLAY	
RECORD	
DEVICES	
DCCS	
IVS	F.W. 1017
NOTIFY	DEVICE AVT Series
JOYSTICK	CONNECTION OK
EXIT	

2.2.3 Other brand's speed dome camera

Note: The recorder must support RS485 connection to connect a speed dome camera. Please check the specifications of your recorder for details.

- STEP 1: Connect the coaxial cable to the DVR.
- STEP 2: Find where the connectors of RS485-A and RS485-B are located on the DVR rear panel, and follow the instructions of your camera manual to connect to the DVR. Then, power on the camera.
- STEP 3: On the DVR side, right click to show the main menu, and go to  (ADVANCED CONFIG) → **DEVICES** to set the camera.
 - a) Select the device to **PTZ**.
 - b) Set the ID to the value the same as the one set in the camera.
 - c) Select the protocol to **P-P**, **P-D**, **S-T** or **S-E**.

Note: **P-P** and **P-D** are protocols used Pelco, and **S-T** and **S-E** are protocols used by Samsung.

- d) Set the baud rate to the value the same as the one set in the camera.
- e) Set the interface to **RS485**.

ADVANCED CONFIG	
CAMERA	CH1 CH2 CH3 CH4
DETECTION	DEVICE PTZ ▼
ALERT	ID 000
NETWORK	PROTOCOL P-P ▼
DISPLAY	RATE 2400 ▼
RECORD	INTERFACE RS485 ▼
DEVICES	
DCCS	
IVS	
NOTIFY	
JOYSTICK	
EXIT	

2.2.4 IP Camera

Note: Check the specifications of your DVR and see if the DVR supports IP camera connection.

STEP 1: Connect the camera to the same switch / router as the one the DVR is connected, and power on the camera.

STEP 2: On the DVR side, move the cursor to the left to show the quick bar, and choose  (IP Search) to find your camera.

IP SEARCH					
IP	PORT	MAC	TYPE	PROTOCOL	STATUS
10.1.1.12	88	00:0e:53:e5:9a:f1	IP CAMERA	AVTECH	UNUSED
10.1.1.12	88	UNKNOWN	IP CAMERA	ONVIF	UNUSED

			CONNECT	SETUP	EXIT
---	--	--	---------	-------	------

STEP 3: Select the IP address which is not used and select **CONNECT** to assign which channel the live video should be displayed.

2.3 DVR Power On

This device should be operated only with the type of power source indicated on the manufacturer's label. Connect the indicated AC power cord to the power adapter, and plug into an electrical outlet.

If your device has a power switch on the rear panel, turn it to "—". The power LED will be on. If your device doesn't have a power switch on its rear panel, the power is on once the power source is connected.

Note: Before the DVR is powered on, make sure (1) the cameras are connected and power-supplied for the detection of the camera video system to be correct, and (2) a monitor is connected to the DVR for correct video output detection.

Note: To ensure that your DVR works constantly and properly, it's recommended to use an UPS, Uninterruptible Power Supply (Optional), for continuously operation.

Note: When your DVR is powered on, please check the chapter of "3. FOR INITIAL USE" in the user manual to know how to configure this device and change the default user name and password. To download the user manual, please scan the QR code on the first page, or go to www.surveillance-download.com/user/z404.swf.

3. FOR INITIAL USE

For the first time to power on this device, you might be prompted to:

- Go through the setup wizard
- Clear hard disk
- Change default user name and password

3.1 Setup Wizard

The setup wizard is prompted to guide you finishing the most common settings you might need to do.

Note: It's okay to skip the wizard. You can configure the following settings later in their respective menus.

SETUP WIZARD	
	ENGLISH ▼
<p>WELCOME TO THE SETUP WIZARD.</p> <p>PLEASE FOLLOW THE WIZARD TO FINISH BASIC CONFIGURATIONS.</p>	
<input type="button" value="SKIP"/>	<input type="button" value="EaZy"/> <input type="button" value="NEXT"/>

Choose **EaZy** (EaZy Networking) to directly go to the EaZy Networking setting page, and refer to “APPENDIX 8 EAZY NETWORKING” at page 79 for details.

Note: To configure network setup by using EaZy Networking later, please go to **QUICK START → EaZy**.

Or select “NEXT” to go to the next step.

SETUP WIZARD	
<p>PLEASE INPUT THIS MACHINE NAME</p> <div style="border: 1px solid black; width: 100px; height: 15px; margin: 0 auto;"></div>	
<input type="button" value="SKIP"/>	<input type="button" value="PREV"/> <input type="button" value="NEXT"/>

Name the device. If you don't want to name the device, just skip to the next step.

Note: To name the device later, please go to **SYSTEM → SYSTEM INFO**.

SETUP WIZARD	
USER NAME	office_hd
PASSWORD	office145
CONFIRM PASSWORD	office145
<p>PLEASE INPUT THE ADMINISTRATOR'S USER NAME AND PASSWORD.</p>	
<input type="button" value="SKIP"/>	<input type="button" value="PREV"/> <input type="button" value="NEXT"/>

Change the default user name and password. If you don't change the user name and password here, you're not able to go to the next step. This step is compulsory.

Note: To change or edit user name and passwords, please go to **SYSTEM → ACCOUNT**.

SETUP WIZARD	
DATE	2015/MAR/05
TIME	14:33:46
FORMAT	Y/M/D ▼
GMT	GMT+08:00 ▼
<input type="button" value="SKIP"/> <input type="button" value="PREV"/> <input type="button" value="NEXT"/>	

Set the date and time.

If you don't want to set the date and time now, just skip to the next step. However, it's necessary to keep the date and time right to ensure the accuracy of the recorded data.

Note: To set the date and time later, please go to **QUICK START** → **TIME SETUP** ("6.1.2 TIME SETUP" at page 24). When the date and time are changed, you'll be prompted to clear the hard disk(s). Select **YES** to erase the previous recorded data, or there might be data disorder and you wouldn't find the footage you need.

SETUP WIZARD	
NTP SERVER	Pool.ntp.org
SYNC PERIOD	OFF ▼
<input type="button" value="SKIP"/> <input type="button" value="PREV"/> <input type="button" value="NEXT"/>	

Configure if you want to connect this device to an NTP server to get the right time online.

Note: To set the date and time later, please go to **QUICK START** → **TIME SETUP** ("6.1.2 TIME SETUP" at page 24).

SETUP WIZARD	
NETWORK TYPE	STATIC ▼
IP	192.168.1.10
GATEWAY	192.168.1.1
NETMASK	255.255.255.0
PRIMARY DNS	8.8.8.8
SECONDARY DNS	168.95.1.1
PORT	80
<input type="button" value="SKIP"/> <input type="button" value="PREV"/> <input type="button" value="NEXT"/>	

Configure network setup by using the traditional method. For details, please download www.surveillance-download.com/user/network_setup/network_setup_recorder.pdf.

Note: To configure network setup by using the traditional method later, please go to **ADVANCED CONFIG** → **NETWORK** ("NETWORK" at page 39).

SETUP WIZARD	
SMTP SERVER	Smtplib@gmail.com
PORT	465
MAIL FROM	manager@gmail.com
SSL ENCRYPTION	ON
VERIFY PASSWORD	ON
USER NAME	manager@gmail.com
PASSWORD	●●●●●●
<input type="button" value="SKIP"/> <input type="button" value="PREV"/> <input type="button" value="NEXT"/>	

Configure event notifications by email.

Note: To configure email notifications later, please go to **ADVANCED CONFIG** → **NETWORK** -> **EMAIL** ("E-MAIL" at page 39).

SETUP WIZARD	
DDNS	ON
SYSTEM NAME	Eagleeyes ▼
HOST NAME	MAC000E533A3D
E-MAIL	
CURRENT HOST ADDRESS MAC000E533A3D4A.ddns.eagleeyes.tw	
<input type="button" value="SKIP"/>	<input type="button" value="PREV"/> <input type="button" value="NEXT"/>

Enable DDNS if needed.

Note: To enable the DDNS later, please go to **ADVANCED CONFIG** → **NETWORK** → **DDNS** ("NETWORK" at page 39).

3.2 Clear Hard Disk

When this device is powered on, hard disk detection will be on, and you'll be prompted to clear the hard disk(s):

CLEAR HDD	
CLEAR HDD HDD0	
<input type="button" value="YES"/>	<input type="button" value="NO"/>

Please choose "YES" to clear the connected hard disk(s), or this device will not detect hard disks properly for video recording.

It might take some time to clear the connected hard disk(s). When it's done, you'll see the remaining hard disk capacity on the top right corner of the screen.

Note: It's necessary to clear hard disks in order to format the connected disks to the right format to save video data. The format used for this device can **NOT** be read directly on a PC. Please do not install the hard disk directly to a PC and try to copy the video data saved in the hard disk. The video data might be impaired.

To change later, right click to show the main menu, and select  (SYSTEM) → **SYSTEM INFO** → **CLEAR HDD**. The DVR will reboot when hard disk data are cleared.

SYSTEM																													
<table border="1" style="width: 100%; border-collapse: collapse;"> <tr><td>ACCOUNT</td></tr> <tr><td>TOOLS</td></tr> <tr style="background-color: #000080; color: white;"><td>SYSTEM INFO</td></tr> <tr><td>ONLINE</td></tr> <tr><td>BACKUP DATA</td></tr> <tr><td>BACKUP LOG</td></tr> </table>	ACCOUNT	TOOLS	SYSTEM INFO	ONLINE	BACKUP DATA	BACKUP LOG	<table style="width: 100%;"> <tr> <td>BAUD RATE</td> <td style="text-align: right;">2400 ▼</td> </tr> <tr> <td>HOST ID</td> <td style="text-align: right;">000</td> </tr> <tr> <td>R.E.T.R</td> <td style="text-align: right;">5 ▼</td> </tr> <tr> <td>AUTO KEY LOCK(S)</td> <td style="text-align: right;">NEVER ▼</td> </tr> <tr> <td>CLEAR HDD</td> <td style="text-align: right;">HDD-0 ▼</td> </tr> <tr> <td>RESET DEFAULT</td> <td style="text-align: right;">SUBMIT</td> </tr> <tr> <td>REMOTE CONTROL ID</td> <td style="text-align: right;">000</td> </tr> <tr> <td>DEVICE TITLE</td> <td style="text-align: right;">OFFICE</td> </tr> <tr> <td>SERIAL TYPE</td> <td style="text-align: right;">RS485</td> </tr> <tr> <td>VIDEO FORMAT</td> <td style="text-align: right;">NTSC</td> </tr> <tr> <td>VERSION</td> <td style="text-align: right;">1019-1008-1010-1010</td> </tr> </table>	BAUD RATE	2400 ▼	HOST ID	000	R.E.T.R	5 ▼	AUTO KEY LOCK(S)	NEVER ▼	CLEAR HDD	HDD-0 ▼	RESET DEFAULT	SUBMIT	REMOTE CONTROL ID	000	DEVICE TITLE	OFFICE	SERIAL TYPE	RS485	VIDEO FORMAT	NTSC	VERSION	1019-1008-1010-1010
ACCOUNT																													
TOOLS																													
SYSTEM INFO																													
ONLINE																													
BACKUP DATA																													
BACKUP LOG																													
BAUD RATE	2400 ▼																												
HOST ID	000																												
R.E.T.R	5 ▼																												
AUTO KEY LOCK(S)	NEVER ▼																												
CLEAR HDD	HDD-0 ▼																												
RESET DEFAULT	SUBMIT																												
REMOTE CONTROL ID	000																												
DEVICE TITLE	OFFICE																												
SERIAL TYPE	RS485																												
VIDEO FORMAT	NTSC																												
VERSION	1019-1008-1010-1010																												
<input type="button" value="EXIT"/>																													

3.3 Change User Name and Password

It's highly recommended to change the user name and password of this device to keep your account safe. Otherwise, any person could access this device if he knows the default user name and password.

If you didn't go through the setting wizard at the first place, you'll be prompted to change the user name and password:

WARNING	
PLEASE BE ADVISED TO MODIFY THE DEFAULT ACCOUNT TO ENSURE YOUR INFORMATION SECURITY.	
<input checked="" type="radio"/> MODIFY <input type="radio"/> REMIND ME LATER <input type="radio"/> DON'T REMIND ME ANYMORE	
<input type="button" value="CONFIRM"/>	

Choose **MODIFY** to start the change immediately.

To change later, right click to show the main menu, and select  (SYSTEM) → **ACCOUNT** to change the default user name and password of **SUPERVISOR**.

SYSTEM			
ACCOUNT	USER LIST	GROUP	
TOOLS	USER NAME	GROUP	
SYSTEM INFO	admin	SUPERVISOR	
ONLINE			
BACKUP DATA			
BACKUP LOG			
EXIT	ADD	EDIT	DEL

4. USER INTERFACE

4.1 DVR Access

Connect your USB mouse to one of the USB ports on the DVR front panel, and check if there's a mouse icon (🖱️) on the screen, indicating the USB mouse is detected properly.

Move your mouse to enter the DVR password with the password keypad. The default user name and password are both "admin". The status will be changed from 🔒 (key lock) to 🔓 (unlock).

Note: You may configure four different user levels to have different access privileges in **SYSTEM** → **ACCOUNT**. For details, please refer to "5.2 User Level Creation" at page 15.

Password Input

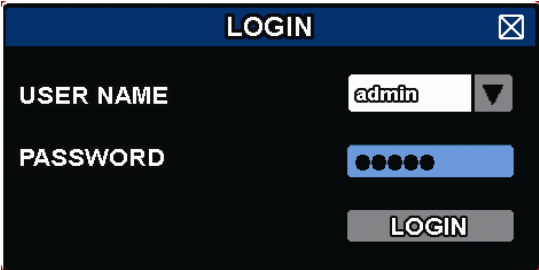

4.2 Live Page



4.2.1 DVR Status

Note: Certain icons are for selected models only.

	Key lock		Key unlock
	Overwrite on		Overwrite off
	Internet disconnected		Internet connected
	Local connection		USB mouse connected
	USB flash drive / device connected		No USB device connected
	IVS on		Click to mute an alert buzzer when it sounds
	Timer record on		Timer record off
	PTZ mode on		PTZ mode off
	Sequence mode on		Sequence mode off
	Backup event queued and USB flash drive needed		USB flash drive full

4.2.2 Channel Status

Note: The functions shown may vary based on the model or the access user level you use.

For Analog Camera

	Live audio on		Audio off		Audio playback on		Audio playback off
	Recording		PTZ control		Motion event		Alarm event
	PIR event		Virtual fence event		One way pass event		Scene Change event

For IP Camera

	Auto search on		Auto search off		Original size		Fit to screen
	Live audio on		Audio off		Audio playback on		Audio playback off
	Recording		PTZ control		Alarm event		Motion event
	Live information		Playback information		Quick camera control		

4.2.3 Record-related Icons

1) Manual Recording

By defaults, manual recording is on (●) when the DVR is powered on and a hard disk is installed.

2) Event Recording

The event icons, / / / / / , show on the channel status bar when their respective events occur and the related record function is on.

3) Timer Recording

When timer recording is on, you will see on the screen.

4) HDD Overwritten

Be defaults, the HDD overwritten function is set to ON, and will be shown on the screen.

Note: To disable this function, right click to display the main menu in the live view, and go to (ADVANCED CONFIG.) → **RECORD** → **OVERWRITE**.

4.3 Quick Menu Bar

Move to the arrow mark to extend the quick menu bar and show the five functions as follows:

Quick Menu: Open

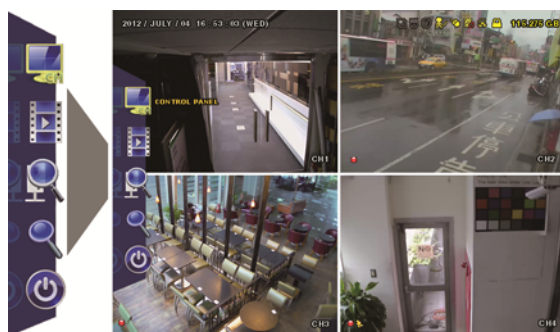

- Click to show the channel switch panel and select the channel you want.

- Click to display the playback control panel, and click to play the latest recorded video clip, or click to enter the search list.

- Available only for models which support IP camera connection.*
 Search for any IP camera(s) connected and assign the camera to a specific channel. For details, please check "2.2.4 IP Camera" at page 7.

- Switch to the channel you want first, and click to enter the zoom-in mode. In this mode, click and drag the red frame on the bottom left of the screen to move to the place you want to see. To exit this mode, click .





- Click to show the power off panel to either halt or reboot the system.

4.4 Main Menu

Right-click anywhere on the screen to show the main menu as follows, and right-click again to exit.

Main Menu







	QUICK START	Click to set the status display, image settings, and date & time.
	SYSTEM	Click to set the system configurations.
	EVENT INFORMATION	Click to enter the event search menu.
	ADVANCED CONFIG	Click to set CAMERA, DETECTION, ALERT, NETWORK, DISPLAY, RECORD, DEVICES*, DCCS, IVS*, NOTIFY* and JOYSTICK.
	SCHEDULE SETTING	Click to set timer for record, motion detection, alarm (in and out)*, Push Video*, buzzer, regular report, auto backup, and regular reboot.

** For selected models only*

5. FREQUENTLY-USED FUNCTIONS

5.1 Key Lock / Unlock

To lock or unlock local operation, click  (unlock) or  (lock) on the DVR status bar to change the status to  (lock) or  (unlock).

To unlock local operation, you'll be prompted to enter the user name and password to access.

Note: The default user name and password are both **admin**, which is the highest user level.

Note: Different user level has different access privilege for certain DVR functions. Please refer to "5.2 User Level Creation" at page 15.

5.2 User Level Creation







Note: This function is available only for **SUPERVISOR**.









To create different user account for different access privilege, click  (SYSTEM), and select **ACCOUNT** to enter **USER LIST**.

SYSTEM			
ACCOUNT	USER LIST	GROUP	
TOOLS	USER NAME	GROUP	
SYSTEM INFO	admin	SUPERVISOR	
ONLINE	power	POWER USER	
BACKUP DATA	normal	NORMAL	
BACKUP LOG	guest	GUEST	
EXIT	ADD	EDIT	DEL

Different user group has different access privilege for certain functions as described below:

Note: It's also available to create a new user group and customizing its access rights. For details, please refer to "GROUP" at page 26.

	Function	User Group			
		SUPERVISOR	POWER	USER	GUEST
■ DVR status					
	Key lock / unlock	✓	✓	✓	✓
■ Channel status					
	Live audio on / off	✓	✓	✓	
	Playback audio on / off	✓	✓	✓	
	Full screen / original size display	✓	✓	✓	✓
	PTZ Control	✓	✓		
	Manual alarm out	✓	✓		

	Function	User Group			
		SUPERVISOR	POWER	USER	GUEST
■ Quick menu bar					
	Channel Selection	✓	✓	✓	✓
	Playback	✓	✓		
	IP Search	✓			
	Digital Zoom	✓	✓	✓	✓
	Power	✓			
■ Main menu					
	Quick Start	✓			
	System	✓			
	Event Information	✓			
	Advanced Config.	✓			
	Schedule Setting	✓	REGULAR REBOOT	REGULAR REBOOT	REGULAR REBOOT
■ Playback control					
	Fast Forward	✓	✓		
	Fast Rewind	✓	✓		
	Play / Pause	✓	✓		
	Stop	✓	✓		
	Slow Playback	✓	✓		
	Previous / Next Hour	✓	✓		
	Quick Search	✓	✓		

5.3 PTZ Control













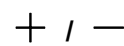

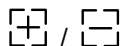



Note: This function is available only for **SUPERVISOR** and **POWER USER**. To know more details, please refer to “5.2 User Level Creation” at page 15.

Note: For our brand’s HD CCTV motorized camera series, click  might only show specific icons for focal length and focus adjustment. For details, please refer to its own user manual.

In the full view





In the split view, click the channel you want to switch to the full screen mode, and click  to show the PTZ control panel.



	Enter	Click to confirm your selection / enter the menu.
	Up / Down / Left / Right	Click the arrow keys (▲ / ▼ / ◀ / ▶) to move the camera lens up / down / left / right.
	Iris + / Iris -	This two buttons are designed for the PTZ camera which uses Pelco-D to control. To know the actions after clicking Iris + and Iris -, please refer to the camera’s user manual.
	Zoom in / out max	Click to zoom in on the image to the largest / zoom out on the image to its original size.
	Zoom in / out	Click to zoom in / out on the image. Users could also zoom in / out on the image by simply drawing a square on the screen, and the zoom ratio depends on how large the square is. <ul style="list-style-type: none"> ■ Zoom in: Draw the square from top left to bottom right. ■ Zoom out: Draw the square from bottom right to left top.
	Focus near / far	Click to adjust the focus of the image.
	Auto mode	Click to activate the auto function. Before using it, you need to assign a specific function that will be enabled when  is clicked. For details, please refer to the user manual of the camera.
	Auto tracking	Click to start auto tracking when your speed dome camera supports this function.
	Preset point	Click to enter the PTZ preset point you want to see.
	Camera Menu	Click to enter the camera main menu. For details about each camera menu, please refer to its own user manual.
	Manual Focus	This function is used to memorize the focus parameters you’ve made after you use  /   /  to manually adjust the focal length and focus. The next time when you move to the same focal length, the camera will use the parameters as the ones for Auto Focus.
	Auto Focus	Click to automatically adjust the focus of the camera.
	Joystick	Click to control the movement of a speed dome camera or a motorized-pan camera. Drag and hold the mouse on the screen to move the camera. You’ll see ● and ●➤ on the screen. The farther these two icons, the faster the movement.
	Config.	Click to configure the speed to pan / tilt the speed dome camera.

In the split view



Click  on the channel status bar to display the panel as follows:

		Up / Down / Left / Right	Click to move your selection up / down / left / right, or change settings.
		Digital zoom in / out	Click to zoom in / out the camera image digitally.
		Focus near / far	Click to adjust the focus of the image.
		Preset point	Click to display the preset point panel for preset point viewing or setting. For details, please refer to the section below.

How to set a preset point:

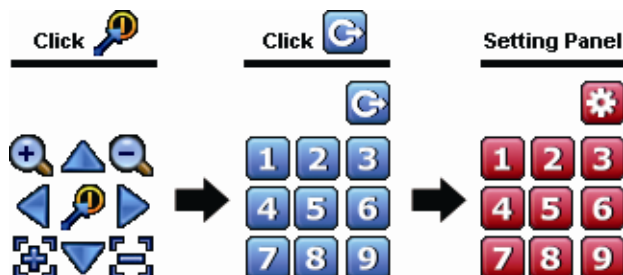
Step1:

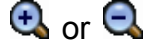

Step2: Click  to the proper ratio you need, and click  to move to the point you want to configure as a preset point.

Step3: Click the numbering you want to configure for this point, and wait till you see  (command sending) appearing and disappearing on the DVR status bar.

Step4: Repeat from Step1 again to set other points if needed, or click  to return to the preset point selection panel.

How to go to a preset point:

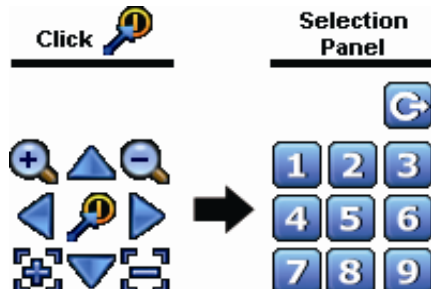

Step1:



Step2: Select the numbering within which saves the camera view you want to see, and wait till you see  (command sending) appearing and disappearing on the DVR status bar.

5.4 Playback











Note: This function is *NOT* available for **GUEST**. Please refer to "5.2 User Level Creation" at page 15.

Click  on the quick menu bar to display the playback control panel, and click  to play the latest recorded video clip, or click  to enter the search list.



Note: There must be at least 8192 images of recorded data for playback to work properly. If not, the device will stop playback. For example, if the IPS is set to 30, the recording time should be at least 273 seconds (8192 images / 30 IPS) for the playback to work properly.



5.4.1 Playback Control

	Fast Forward	Increase the speed for fast forward. Click once to get 4X speed forward and click twice to get 8X speed, etc., and the maximum speed is 32X.
	Fast Rewind	Increase the speed for fast rewind. Click once to get 4X speed rewind and click twice to get 8X speed, etc., and the maximum speed is 32X.
	Play / Pause	Click to play the latest recorded video clip immediately, and click again to pause. In the pause mode, click  once to get one frame forward, and click  to get one frame rewind.
	Stop	Click to stop the video playback.
	Slow Playback	Click once to get 1/4X speed playback, and click twice to get 1/8X speed playback.
	Previous / Next Hour	Click to jump to the next / previous time interval in an hour, for example, 11:00 ~ 12:00 or 14:00 ~ 15:00, and start playing the earliest event video clip recorded during this whole hour.
	Repeat	Click to set point A and point B in a video clip, and the system will play only the specified range in that clip.
	Backup	Click to open the backup menu for video backup.

5.4.2 Event Search

Click  to quickly search the recorded files by event types, or select **FULL** to show all the event logs. To quickly search the time you want, select **QUICK SEARCH**.

5.4.3 Audio Playback

In the playback mode, click  or  on the channel status bar to play or mute audio recording.

Note: To make a video backup with audio, or play a recording with audio, make sure the camera which supports the audio function is connected to the video-in channel and audio-in channel. For example, the audio data from audio CH1 will be recorded with the video data from video CH1. For 16CH models, the audio CH1 ~ CH4 are corresponding to video CH1 ~ CH4 respectively.

5.5 Video Backup

Note: This function is available for **SUPERVISOR**. For details, please refer to "5.2 User Level Creation" at page 15.

Note: Before using your USB flash drive for video backup, please format it to "FAT32" first with your PC or laptop. For the list of compatible USB flash drives, please refer to "APPENDIX 4 COMPATIBLE USB FLASH DRIVE LIST" at page 74.

Note: Video backup could be made via a USB flash drive or the Internet. It's **NOT** allowed to connect the hard disk to your PC / laptop directly for it may impair the recorded data saved in the hard disk.

To copy video data for video backup, click  (SYSTEM), and select **BACKUP DATA**.

SYSTEM		
ACCOUNT	START DATE	2009/NOV/19
TOOLS	START TIME	08:30:21
SYSTEM INFO	END DATE	2009/NOV/19
ONLINE	END TIME	17:59:29
BACKUP DATA	CHANNEL	3 SELECTED
BACKUP LOG		<input type="checkbox"/> ALL
		<input checked="" type="checkbox"/> CH1
		<input checked="" type="checkbox"/> CH2
		<input checked="" type="checkbox"/> CH3
		<input type="checkbox"/> CH4
		<input type="checkbox"/> CH5
	HARD DISK	ALL HDD
	OUTPUT FILE FORMAT	AVI
	TARGET DEVICE	USB DEVICE
	BACKUP	SUBMIT
	REQUIRE SIZE: 554MB	SUBMIT
EXIT	AVAILABLE SIZE: 3788.0MB	

Step1: Select the time within which includes the video data you want to backup.

Step2: Select the channel(s) within which includes the video data you want to backup.

Step3: In **OUTPUT FILE FORMAT**, select the output video format: **DEFAULT / AVI**.

- When **DEFAULT** is selected, the footage is saved to ".dv5", and you can only open it with our own video player on PC. For details, please check "5.6 Video Playback on PC (.dv5)".

Note: It's recommended to save the file to the default format for security reasons. Only specific video player supports the default format and not everyone can see the video footage.

- When **AVI** is selected, the footage will be converted to "avi", and you can open it with any media player which supports the "avi" format on PC.

Step4: In **TARGET DEVICE**, select **USB DEVICE** for video backup.

Step5: In **REQUIRE SIZE**, select **SUBMIT** to know the file size of the selected footage.

Step6: In **BACKUP**, select **SUBMIT** to start copying footage to your USB flash drive, and wait till the backup successful message appears.

5.6 Video Playback on PC (.dv5)

For video backup with the format ".dv5", you can only use our own player to play.

Note: It's **NOT** allowed to remove the hard disk installed in the DVR and connect it directly to your PC to check recorded video clips. It might impair the files saved in the hard disk, causing the loss of those files even when the disk is replaced back to the DVR.

To play ".dv5" video on your PC:

Step1: Insert the USB flash drive with recorded data into your PC.

Note: The supported PC operating systems are Windows 10, Windows 8, Windows 7, Windows Vista & Windows XP.

Step2: Find the program "PLAYER.EXE" in the USB flash drive, and double-click it to install.

Note: "PLAYER.EXE" can also be downloaded from www.surveillance-download.com/user/z404.swf.

Step3: Run the program, *VideoPlayer*, and browse to where you save the recorded data.

Step4: Select the file you want to start video playback.

5.6.1 Convert the file format to AVI

To convert the video file format to AVI, click **AVI** from the playback panel to start file conversion.

Note: The recorded audio (if any) will be removed when the file format is converted to AVI.

Note: If the footage includes data for multiple channels, click to a specific channel for this function to work properly.



5.7 Digital Zoom



Switch to the channel you want to zoom in, and move to the left side of the screen to show the quick start bar.

Click  to enter the zoom-in mode. In this mode, click and drag the red frame on the bottom left of the screen to move to the place you want to see.

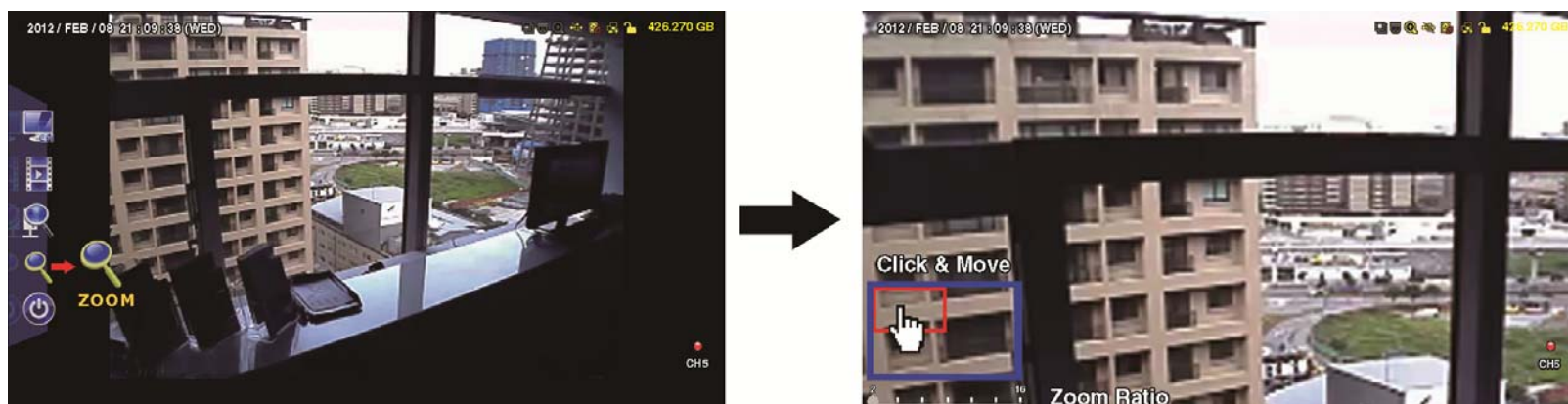

To exit this mode, right-click anywhere on the screen.

Note: You need to exit the zoom mode first to use other DVR functions.

6. MAIN MENU

6.1 QUICK START

6.1.1 GENERAL

QUICK START	
GENERAL	CHANNEL TITLE ON
TIME SETUP	EVENT STATUS ON
DAYLIGHT	DATE DISPLAY ON
EaZy	DCCS DISPLAY ON
	MOUSE SENSITIVITY 0 5 10
	AUDIO GAIN 0 5 15
	RECORD CONFIG SETUP
EXIT	

- 1) CHANNEL TITLE
Select to display the channel title or not (**ON / OFF**).
- 2) EVENT STATUS
Select to display the event icons or not (**ON / OFF**).

Note: For details about each event icon, please refer to "4.2 Live Page" at page 12.

- 3) DATE DISPLAY
Select to display the date or not (**ON / OFF**).
- 4) DCCS DISPLAY
Select to display the OSD or not (**ON / OFF**) when users are using specific camera functions.

Note: This function is available only when the connected HD CCTV camera is the same brand as this recorder.

- 5) MOUSE SENSITIVITY
Select the mouse sensitivity. The higher the value, the more sensitive the mouse.
- 6) AUDIO GAIN
Select the level to enhance the audio signals. The higher the value, the stronger the signals.

7) RECORD CONFIG

Click **SETUP** to enter the setting page individually for manual record, event record and timer record.

a) Select the record type you want to set.

b) In **CHANNEL**, select **ALL** to apply the changes here to all channels.

Note: The I.P.S. section is based on NTSC system.

QUICK START				
MANUAL RECORD	EVENT RECORD	TIMER RECORD		
CHANNEL	IMAGE SIZE	I.P.S.	QUALITY	BITRATE (kbps)
ALL	FHD(1080P)	240	SUPER BEST	2064
				EXIT

Or, select **BY CHANNEL** to set the image size, image per second & image quality individually for each channel.

Note: The available options for **IMAGE SIZE** depend on the recorder you have.

Note: Some models support up to 5MP (2592 x 1944) video recording for IP cameras. However, when the image size is set to 3MP (2048 x 1536) or more, the local live display and playback will be set to sub stream display (D1 by default). To check the recording at 3MP or more resolution, please copy and play it on a PC / laptop.

IMAGE SIZE	The pixels of the image, for example, FHD(1080P) = 1920 x 1080. The more the pixels, the clearer the image but the more the file size.
I.P.S.	Image per second. The more the I.P.S., the more fluent the video but the more the file size.
QUALITY	Image quality.
BITRATE	It is used to set the upper limit of the transmission number per second. The value could be configured from 256 up to 8192 depending on the DVR model you have. The value set here is related to the image size. For example, here are the recommended values: <ul style="list-style-type: none"> ■ FHD(1080P) => 2048 ■ HD(720P) => 1024 The more the value, the bigger the file size, but the system stability might go down. The less the value, the smaller the file size, but the image quality might go down.

6.1.2 TIME SETUP

QUICK START	
GENERAL	DATE 2009 / NOV / 17
TIME SETUP	TIME 15 : 35 : 53
DAYLIGHT	NTP SERVER tock.stdtime.gov.tw
EaZy	FORMAT Y/M/D
	SYNC PERIOD DAILY
	GMT (GMT+08:00)TAIPEI
EXIT	

1) DATE

Set the current date. The default display format is YEAR – MONTH – DATE (**Y-M-D**).

2) TIME

Set the current time in HOUR : MIN : SEC.

3) NTP SERVER

Click to change the default NTP server to another server they're familiar with, or keep the default NTP server.

Note: This function works only when this device is configured to the Internet.

4) FORMAT

Select one date format from the following three options: **Y/M/D**, **M/D/Y** or **D/M/Y**.

5) SYNC PERIOD

Select to synchronize the time every day (**DAILY**), or turn this function off (**OFF**).

6) GMT

Select your time zone.

6.1.3 DAYLIGHT

QUICK START	
GENERAL	DAYLIGHT SAVING ON
TIME SETUP	START TIME
DAYLIGHT	1ST MON AUG 06:00
EaZy	END TIME
	LAST MON OCT 10:00
	ADJUST 01:00
EXIT	

Depending on the time zone you're in:

1) DAYLIGHT SAVING

Select to enable (**ON**) or disable (**OFF**) this function.

2) START TIME / END TIME

Set the start time and end time.

3) ADJUST

Set the time in HOUR : MIN.

6.1.4 EaZy

EaZy Networking is a cloud service to connect your devices to the Internet automatically through our free mobile app, EagleEyes, in a few steps without going through the complicated network setup including port forwarding.

For details, please refer to “APPENDIX 8 EAZY NETWORKING” at page 79.

QUICK START	
GENERAL TIME SETUP DAYLIGHT EaZy	ENABLE EAZY NETWORKING ON  000E532B8613
EXIT	

6.2 SYSTEM

6.2.1 ACCOUNT

USER LIST

This function is used to create a new user account, or modify or delete an existing account for different access privilege.

Note: For details about available local operations of each user level, please refer to “5.2 User Level Creation” at page 15.

SYSTEM			
ACCOUNT	USER LIST	GROUP	
TOOLS SYSTEM INFO BACKUP DATA BACKUP LOG	USER NAME	GROUP	
	admin	SUPERVISOR	
	power	POWER USER	
	user	NORMAL	
	guest	GUEST	
EXIT	ADD	EDIT	DEL

■ How to create an account

Select **ADD**, enter a user name and its password, and assign a user group in which includes the access rights you wish to grand to this new account. Then, select **SAVE** to create and return to the user list page.

ADD	
USER NAME	TEST1
PASSWORD	●●●●●●●●
CONFIRM PASSWORD	●●●●●●●●
GROUP	GUEST ▼
SAVE	CANCEL

GROUP

This function is used to create a new group with customized user access rights for different functions if needed, and you can create a user account and assign it to your customized group.

Note: The default user groups are **SUPERVISOR**, **POWER USER**, **USER** and **GUEST**, and they're not allowed to be removed. For details about available local operations of each user group, please refer to "5.2 User Level Creation" at page 15.

SYSTEM						
ACCOUNT	USER LIST	GROUP				
		GENERAL	LIVE	PLAYBACK	NETWORK LIVE STREAM	NETWORK PLAYBACK STREAM
TOOLS SYSTEM INFO ONLINE BACKUP DATA BACKUP LOG	+ - 🔒 SUPERVISOR 🔒 POWER USER 🔒 USER 🔒 GUEST	BACKUP PTZ CONTROL POWER CONTROL REVIEW LOG CONFIG SETUP CLEAR LOG ACCOUNT SETUP CLEAR HDD PUSH VIDEO PUSH STATUS ALARM OUT				ALL ENABLE ENABLE ENABLE ENABLE DISABLE DISABLE DISABLE DISABLE DISABLE ENABLE
	EXIT					

■ How to create a group and customize access rights

Step1: Enter a name in the column next to **+**, and select **+** to create a group. You'll find it added in the group list.

Step2: Select the group you just added in the group list, and select the tabs of **GENERAL**, **LIVE**, **PLAYBACK**, **NETWORK LIVE STREAM** and **NETWORK PLAYBACK STREAM** to choose the corresponding functions you want to enable or disable.

Step3: Return to **USER LIST**, and create an account or modify an existing account to assign it to the group you just added.

6.2.2 TOOLS

SYSTEM		
ACCOUNT TOOLS SYSTEM INFO ONLINE BACKUP DATA BACKUP LOG	LANGUAGE UPGRADE NETWORK UPGRADE BACKUP CONFIG RESTORE CONFIG UPGRADE CAMERA PARAMETERS UPGRADE CAMERA FIRMWARE ENABLE AUTO PLUG AND PLAY BIND MAC ADDRESS	ENGLISH SUBMIT SUBMIT SUBMIT SUBMIT UPGRADE UPGRADE ON ON
EXIT		

1) LANGUAGE

Select the language of the OSD.

2) UPGRADE

Save the upgrade files obtained from your installer or distributor in a compatible USB flash drive, and insert it into the USB port at the front panel. Then, click **SUBMIT** to start upgrading.

Note: Before using the USB flash drive, please use your PC to format the USB flash drive to FAT32 format first. For the list of compatible USB flash drives, please refer to "APPENDIX 5 COMPATIBLE USB FLASH DRIVE LIST" at page 74.

Note: After upgrading firmware, it's recommended to clear all HDD data for the system to work more

stably. Before clearing all HDD data, please remember to make video backup.

3) NETWORK UPGRADE

Click **SUBMIT** for perform system upgrade via Internet.

Note: This function requires Internet access. Please make sure this recorder is connected to Internet before using this function.

4) BACKUP CONFIG / RESTORE CONFIG

To save the DVR current configurations for later use, such as restoring after DVR upgrade or applying to another DVR, insert a compatible USB flash drive into the USB port, and select **SUBMIT** in **BACKUP CONFIG** to copy the current DVR configurations to a file "System.bin" and save to your USB flash drive. To restore the DVR configurations, insert the USB flash drive including "System.bin" to the USB port, and select **SUBMIT** in **RESTORE CONFIG**.

5) UPGRADE CAMERA PARAMETERS / UPGRADE CAMERA FIRMWARE

This function is used only to upgrade the parameters / firmware of our brand's HD CCTV camera when necessary.

Get the upgrade file from our installer or distributor and save it to a USB flash drive. Then, select **UPGRADE** to start the upgrade.

6) ENABLE AUTO PLUG AND PLAY

Switch to **ON** allow the camera to be detected and configured automatically when it's connected to this device.

Note: This function is available only when the brand of the cameras connected is the same as this device.

7) BIND MAC ADDRESS

This function is recommended to be used when your surveillance system is more than 256 cameras. It would be helpful for the system to get the address of each connected camera quickly if the system accidentally shuts down and needs to recover.

6.2.3 SYSTEM INFO

SYSTEM	
ACCOUNT	BAUD RATE 2400 ▼
TOOLS	HOST ID 000
SYSTEM INFO	R.E.T.R 5 ▼
ONLINE	AUTO KEY LOCK(S) NEVER ▼
BACKUP DATA	CLEAR HDD HDD-0 ▼
BACKUP LOG	RESET DEFAULT SUBMIT
	REMOTE CONTROL ID 000
	DEVICE TITLE office
	SERIAL TYPE RS485
	VIDEO FORMAT NTSC
	VERSION 1001-1000-1000-1001
EXIT	

1) BAUD RATE

Set the baud rate of the DVR (**2400 / 4800 / 9600 / 19200 / 38400 / 57600 / 115200**).

Note: This function is used when an external controller is connected to this DVR and further configurations should be made for this DVR to work with the controller. For details, please check the user manual of the external controller.

2) HOST ID

Set the ID of the DVR (000 ~ 254).

Note: This function is used when an external controller is connected to this DVR and further configurations should be made for this DVR to work with the controller. For details, please check the user manual of the external controller.

3) R.E.T.R (Remote Event Trigger Recording)

Select the timeout in minute after which the R.E.T.R. function will be activated (**3 / 5 / 10 / 30**).

4) AUTO KEY LOCK(S)

Set the time-out in second after which the key lock function is activated (**NEVER / 30 / 60 / 120**).

5) CLEAR HDD

Select the HDD you want to clear, and click **YES** to confirm or **NO** to cancel.

It's recommended to clear all data in the hard disk when:

- It's the first time to use this DVR to ensure the recorded data are not mixed with other data previously saved in the same hard disk.
- The DVR firmware is upgraded for the system to work more stably. Before clearing all HDD data, please remember to make video backup.
- DVR date and time are changed accidentally when the recording function is activated. Otherwise, the recorded data will be disordered and you will not be able to find the recorded file to backup by time search.

6) RESET DEFAULT

Click "SUBMIT" to reset all settings as default, and select **YES** to confirm or **NO** to cancel. The DVR will reboot after reset.

7) REMOTE CONTROL ID

This function is available when users need to control two or more DVRs with one IR remote controller. The ID set here is used to identify the DVR the remote controller is going to control. Please also read the user manual of the IR remote controller for details.

8) DEVICE TITLE

Enter a title for this device.

9) SERIAL TYPE

Here shows the serial type of the DVR (**RS-485**).

10) VIDEO FORMAT

Here shows the information of the DVR video format (**NTSC / PAL**).

11) VERSION

Here shows the firmware version information.

6.2.4 ONLINE

Insert a compatible USB flash drive to the USB port at the front panel.

Note: Before using your USB flash drive for video backup, please format it to "FAT32" first with your PC or laptop. For the list of compatible USB flash drives, please refer to "APPENDIX 4 COMPATIBLE USB FLASH DRIVE LIST" at page 74.

SYSTEM		
ACCOUNT	ANONYMOUS VIEWER LOGIN	OFF
TOOLS	LOGIN WITH CAPTCHA IMAGE	ON
SYSTEM INFO	DROP ALL VIDEO CONNECTION	SUBMIT
ONLINE	LOGIN FAILURE NUMBER	3 ▼
BACKUP DATA	LOCK TIME OF LOGIN FAILURES	1 MINS ▼
BACKUP LOG		
EXIT		

1) ANONYMOUS VIEWER LOGIN

Switch to **ON** to allow anonymous login, meaning there's no need to enter user name and password for remote access.

2) LOGIN WITH CAPTCHA IMAGE

To allow image code verification at login to avoid malicious attack, switch to **ON**; to disable image code verification at login, switch to **OFF**.

3) DROP ALL VIDEO CONNECTION

Click **SUBMIT** to force disconnection of all remote logins when needed.

4) LOGIN FAILURE TIMES

Select how many times of remote login failures (1 ~ 20) to enable device lock automatically for security reasons.

5) LOCK TIME FOR LOGIN FAILURES

Select the device lock time (**1 MIN / 2 MINS / 3 MINS / 5 MINS / 10 MINS / 30 MINS / 1 HOUR**) when remote login failures reach to the number specified in **LOGIN FAILUTRE TIME(S)**. You'll be unable to see the login page of this device until the specified time is up.

6.2.5 BACKUP DATA

Note: It's **NOT** allowed to remove the hard disk installed in the DVR and connect it directly to your PC to check video footage. It might impair the files saved in the hard disk, causing the loss of those files even when the disk is replaced back to the DVR.

Note: This function is available only when a hard disk is installed.

Insert a compatible USB flash drive to the USB port at the front panel.

Note: Before using your USB flash drive for video backup, please format it to "FAT32" first with your PC or laptop. For the list of compatible USB flash drives, please refer to "APPENDIX 4 COMPATIBLE USB FLASH DRIVE LIST" at page 74.

SYSTEM	
ACCOUNT	START DATE 2009/NOV/19
TOOLS	START TIME 08:30:21
SYSTEM INFO	END DATE 2009/NOV/19
ONLINE	END TIME 17:59:29
BACKUP DATA	CHANNEL ALL ▼
BACKUP LOG	HARD DISK ALL HDD ▼
	OUTPUT FILE FORMAT DEFAULT
	TARGET DEVICE USB DEVICE
	BACKUP SUBMIT
	REQUIRE SIZE: 554MB SUBMIT
EXIT	AVAILABLE SIZE: 3788.0MB

1) START DATE / START TIME

Select the start date & time.

2) END DATE / TIME

Select the end date & time.

3) CHANNEL

Click to select the channel(s).

4) HARD DISK

Select the hard disk containing the video data you need or **ALL HDD**.

5) OUTPUT FILE FORMAT

Select the file format for backup video: **DEFAULT** or **AVI**.

- When **DEFAULT** is selected, the copied video is saved to ".dv5", and you can only open it with our own video player on PC. For details, please check the next section, "Video Playback on PC (.dv5)".

Note: It's recommended to save the file to the default format for security reasons. Only specific video player supports the default format and not everyone can see the video footage.

- When **AVI** is selected, the copied footage will be converted to "avi", and you can open it with any media player which supports the "avi" format on PC.

6) TARGET DEVICE

Select the device you want to use for video backup: **USB DEVICE**.

7) BACKUP

Click **SUBMIT** to start backup.

8) REQUIRE SIZE

To know the size of the expected backup video before backup, click **SUBMIT** to start calculating.

Video Playback on PC (.dv5)

For video backup with the format “.dv5”, you can only use our own player to play.

Note: It’s **NOT** allowed to remove the hard disk installed in the DVR and connect it directly to your PC to check recorded video clips. It might impair the files saved in the hark disk, causing the loss of those files even when the disk is replaced back to the DVR.

To play “.dv5” video on your PC:

Step1: Insert the USB flash drive with recorded data into your PC.

Note: The supported PC operating systems are Windows 10, Windows 8, Windows 7, Windows Vista & Windows XP.

Step2: Find the program “PLAYER.EXE” in the USB flash drive, and double-click it to install.

Note: “PLAYER.EXE” can also be downloaded from www.surveillance-download.com/user/z404.swf.

Step3: Run the program, *VideoPlayer*, and browse to where you save the recorded data.

Step4: Select the file you want to start video playback.

Convert the file format to AVI:

To convert the video file format to AVI, click **AVI** from the playback panel to start file conversion.

Note: The recorded audio (if any) will be removed when the file format is converted to AVI.

Note: If the footage includes data for multiple channels, click to a specific channel for this function to work properly.



6.2.6 BACKUP LOG

This function is used to export event logs for quick checking or backup. A .csv file will be exported to your USB flash drive. You can open it with a text editor to see the logs.

Note: This function is available only when a hard disk is installed.

Insert a compatible USB flash drive to the USB port at the front panel.

Note: Before using the USB flash drive, please use your PC to format the USB flash drive to FAT32 format first. For the list of compatible USB flash drives, please refer to "APPENDIX 4 COMPATIBLE USB FLASH DRIVE LIST" at page 74.

SYSTEM	
ACCOUNT	START DATE 2009/NOV/19
TOOLS	START TIME 08:30:21
SYSTEM INFO	END DATE 2009/NOV/19
ONLINE	END TIME 17:59:29
BACKUP DATA	CHANNEL ALL ▼
BACKUP LOG	DATA TYPE 3 SELECTED ▲
	<input type="checkbox"/> ALL
	<input checked="" type="checkbox"/> MANUAL ▲
	<input checked="" type="checkbox"/> MOTION
	<input checked="" type="checkbox"/> ALARM
	<input type="checkbox"/> SYSTEM
	<input type="checkbox"/> TIMER ▼
	BACKUP SUBMIT
EXIT	

1) START DATE / START TIME

Select the start date & time.

2) END DATE / TIME

Select the end date & time.

3) CHANNEL

Click to select the channel(s).

4) DATA TYPE

Click "SETUP" to select the event type you want: **MANUAL / MOTION / ALARM / SYSTEM / TIMER / HUMAN DETECTION / INFLOW / OUTFLOW / VIRTUAL FENCE / ONEWAY / SENCE CHANGE**, or select **ALL** to choose all event types.

Note: The event types available depend on the model you have.

5) BACKUP

Click **SUBMIT** to start backup. You'll see a log file (.csv) in the flash drive. You may open it with any txt editor, such as NotePad.

6.3 EVENT INFORMATION

6.3.1 QUICK SEARCH

EVENT INFORMATION																																											
<p>QUICK SEARCH</p> <p>EVENT SEARCH</p> <p>HDD INFO</p> <p>EVENT LOG</p>	<p>CHANNEL 2 SELECTED ▼</p> <div style="border: 1px solid black; padding: 5px; margin: 5px 0;"> <p style="text-align: center;">2009</p> <table border="1" style="width: 100%; text-align: center;"> <thead> <tr> <th>SUN</th> <th>MON</th> <th>TUE</th> <th>WED</th> <th>THU</th> <th>FRI</th> <th>SAT</th> </tr> </thead> <tbody> <tr> <td>1</td> <td>2</td> <td>3</td> <td>4</td> <td>5</td> <td>6</td> <td>7</td> </tr> <tr> <td>8</td> <td>9</td> <td>10</td> <td>11</td> <td>12</td> <td>13</td> <td>14</td> </tr> <tr> <td>15</td> <td>16</td> <td>17</td> <td>18</td> <td>19</td> <td>20</td> <td>21</td> </tr> <tr> <td>22</td> <td style="background-color: #cccccc;">23</td> <td>24</td> <td>25</td> <td>26</td> <td>27</td> <td>28</td> </tr> <tr> <td>29</td> <td>30</td> <td></td> <td></td> <td></td> <td></td> <td></td> </tr> </tbody> </table> </div> <p style="text-align: center;">00 06 12 18 24</p> <p style="text-align: center; font-size: 1.2em;">15 : 20</p>	SUN	MON	TUE	WED	THU	FRI	SAT	1	2	3	4	5	6	7	8	9	10	11	12	13	14	15	16	17	18	19	20	21	22	23	24	25	26	27	28	29	30					
SUN	MON	TUE	WED	THU	FRI	SAT																																					
1	2	3	4	5	6	7																																					
8	9	10	11	12	13	14																																					
15	16	17	18	19	20	21																																					
22	23	24	25	26	27	28																																					
29	30																																										
EXIT	SUBMIT																																										

Step1: Select the channel including the video data you want to search.

Step2: Select the year and month including the video data you want to search from the calendar, and the date with recorded data will be highlighted.

Note: To select the year and month, move your mouse to the display bar. Then, click and hold to drag up or down.

Step3: Select the date you want from the calendar, and the time with recorded data will be highlighted from the time scale bar.

Step4: To immediately play the video clip, click **SUBMIT**.

To choose the start time for video playback, move your mouse cursor to the highlighted time, and click to confirm the time when the time display below is the time you want. The video playback is activated right away when you confirm the time.

Note: For video playback operations, please refer to "5.4 Playback" at page 18.

6.3.2 EVENT SEARCH

EVENT INFORMATION	
<p>QUICK SEARCH</p> <p>EVENT SEARCH</p> <p>HDD INFO</p> <p>EVENT LOG</p>	<p>DATE 2009/NOV/19</p> <p>TIME 16:13:16</p> <p>CHANNEL 1 ▼</p> <p>HARD DISK ALL HDD ▼</p> <p>EVENT TYPE MOTION ▼</p> <p>SEARCH START</p>
EXIT	

1) DATE / TIME

Select the specific time period that you want to search.

2) CHANNEL

Select the video channel you want to search.

3) HARD DISK

Select the hard disk including the video data you want to search, or select **ALL HDD**.

4) EVENT TYPE

Select the event type you want to search (**MOTION / ALARM / HUMAN DETECTION / INFLOW / OUTFLOW / VIRTUAL FENCE / ONEWAY / SCENE CHANGE**), or select **ALL** to choose all events.

Note: Some events are available only for selected models.

5) SEARCH

Click **START** to start search and play the video data immediately.

6.3.3 HDD INFO

You can check the remaining capacity of the connected hard disk in this device and its current status.

If the healthy status goes to:

- **GOOD** - This hard disk works normal.
- **BELOW AVERAGE** - The hard disk might work with some errors. Please pay attention and do video backup if needed.
- **REPLACEMENT NEEDED** – Please replace this hard disk immediately to ensure continuous video recording.

EVENT INFORMATION										
QUICK SEARCH EVENT SEARCH	ID	TYPE	STATUS	SIZE	TEMP.	SERIAL NUMBER	FREE SIZE	FORMAT TIME	HEALTHY STATUS	
	HDD-0	NORMAL	READY	890.562GB	46	ST31000526SV	864.832GB	2011/DEC/13 18:18:53	GOOD	
HDD INFO										
EVENT LOG										
EXIT										

6.3.4 EVENT LOG

You can check all system events (**SYSTEM**) and backup logs (**BACKUP**), or clear all log records.

EVENT INFORMATION			
QUICK SEARCH EVENT SEARCH HDD INFO EVENT LOG	SYSTEM	BACKUP	
	EVENT	TIME	COMMENT
	KEY UNLOCK	2009/NOV/19 15:49:07	
	VIDEO LOSS	2009/NOV/19 15:32:05	04
	POWER ON	2009/NOV/19 15:32:02	
PREV NEXT CLEAN			
EXIT			

6.4 ADVANCED CONFIG

6.4.1 CAMERA

ADVANCED CONFIG				
CAMERA	CH1	CH2	CH3	CH4
DETECTION	INTERFACE			COAXIAL ▼
ALERT	CAMERA TYPE			AUTO ▼
NETWORK	BRIGHTNESS			128
DISPLAY	CONTRAST			128
RECORD	SATURATION			128
DEVICES	HUE			128
DCCS	REC			ON
IVS	TIME STAMP DISPLAY			ON
NOTIFY	CHANNEL TITLE			CH1
JOYSTICK	REC AUDIO			ON
	ALARM OUT DURATION (SECS) <i>(For selected models only)</i>			3
EXIT				

1) INTERFACE

Here shows how the camera is connected to this device: **COAXIAL** or **IPCAM**.

Usually this function will be detected automatically unless you want to change the camera type from an IP camera to an analog camera.

If an IP camera was previously connected and now you want to replace it with an analog camera, please manually change **IPCAM** to **COAXIAL** for the camera detection to work properly.

2) CAMERA TYPE / CONNECTION

When **INTERFACE** is **COAXIAL**, you'll see **CAMEA TYPE** and the options are **AUTO** (default) / **TVI** / **ANALOG HD**.

When **INTERFACE** is **IPCAM**, you'll see **CONNECTION**.

3) BRIGHTNESS / CONTRAST / SATURATION / HUE

Click the current value to manually adjust the brightness/contrast/saturation/hue of each channel here.

4) REC

Select if you want to enable recording for the selected channel (**ON** / **OFF**).

Note: When this function is disabled, no manual, event or timer recording will be activated even if any of these three record functions is set to **ON**.

5) TIME STAMP DISPLAY

Enable this function and the recording time will be shown on the video during video playback.

6) CHANNEL TITLE

Click the channel title column to change the channel title (up to 12 characters). The default title is the channel number.

7) REC AUDIO

Enable or disable audio recording for the selected channel if the connected camera supports audio recording.

8) ALARM OUT DURATION (SECS) *(For selected models only)*

Select the duration time in second when an alarm-out event occurs (**3** / **5** / **10** / **20** / **30**).

6.4.2 DETECTION

ADVANCED CONFIG				
CAMERA	CH1	CH2	CH3	CH4
DETECTION	LS			07
ALERT	SS			03
NETWORK	TS			02
DISPLAY	MOTION			OFF
RECORD	ALARM			OFF
DEVICES	AREA			EDIT
DCCS	PRIVACY MASK			EDIT
IVS	INTERNAL ALARM <i>(For selected models only)</i>			ON
NOTIFY	IPCAM GUARD LOCK			SETUP
JOYSTICK				
EXIT				

1) LS (Level of Sensitivity)

LS is to set the sensitivity of comparing two different images. The smaller the value is, the higher sensitivity for motion detection. The highest sensitivity setting is 00, and the lowest sensitivity setting is 15. The default value is 07.

2) SS (Spatial Sensitivity)

SS is to set the sensitivity for detecting the size of one object (the number of the grids) on the screen. The smaller the value is, the higher sensitivity for motion detection.

The highest sensitivity setting is 00, and the lowest sensitivity setting is 15. The default setting is 03.

Note: The default setting of SS is 03, which means once an object is detected more than 3 grids, the system will get triggered. So the value of SS must be less than the number of grids that you set up for the motion detection area.

3) TS (Time of Sensitivity)

TS is to set the sensitivity regarding how long one object stays in the detection area and triggers the recording. The smaller the value is, the higher sensitivity for motion detection.

The highest sensitivity setting is 00, and the lowest sensitivity setting is 15. The default setting is 02.

4) MOTION

Select if you want to activate the motion detection function for the selected channel (**ON / OFF**).

5) ALARM

Select **N.C.** / **N.O.** depending on your installation need. The default alarm value is **OFF**.

6) AREA



Click **EDIT** to set the motion detection area.

There are 16 × 12 grids per camera for all channels. Pink blocks represent the area that is not being detected while the transparent blocks are the area under detection.

7) PRIVACY MASK

You can cover certain areas on the camera image with privacy masks.

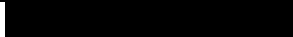
Note: Up to 4 areas could be added.

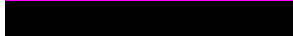
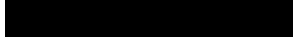
PRIVACY MASK			
NAME	FUNCTION	MOSAIC COLOR	TRANSPARENCY
1	OFF		0%
2	ON		25%
2	OFF		0%
2	OFF		0%

Select one existing profile, and choose **EDIT** to modify it.

■ EDIT

PRIVACY MASK - EDIT	
FUNCTION	ON
MOSAIC COLOR	
TRANSPARENCY	50%
MASK AREA	SETUP

Item	Description
MOSAIC SIZE	Choose the mosaic size of the privacy mask. The options are: 8x8, 32x32, and 64x64.
MOSAIC COLOR	Select the color for the privacy mask.
TRANSPARENCY	Select the transparency for your privacy mask. The options are: 0%, 25%, 50%, and 100%.
MASK AREA	Select "SETUP" to enter the area selection page. To exit, right click on the mouse.

8) INTERNAL ALARM *(For selected models only)*

This function is available only when an HD CCTV camera with a PIR sensor built-in is connected to this device. You could enable or disable the PIR detection here.

Note: To know which camera could work with this function, please check with your installer or distributor.

9) IPCAM GUARD LOCK

This function is available only for the IP camera which supports motorized-pan. It will temporarily disable the pan function of the camera and move the camera angle to a preset area for surveillance when **Guard** is enabled on the mobile app, EagleEyes, remotely.

To use this function, you need to at least have one preset point and preset group configured on your IP camera, and have the mobile app, EagleEyes, installed on your mobile device.

Note: To know how to configure preset points and preset groups, please refer to the user manual of your IP camera. To know where to download the app, EagleEyes, please refer to "7.2 Mobile Devices" at page 61.

IPCAM GUARD LOCK – CH1	
GUARD LOCK	ON
TIMEOUT (SECS)	30 ▼
PRESET GROUP	1 ▼
PRESET NUMBER	3 ▼

Enable **GUARD LOCK**, choose the preset group and point you want to monitor, and configure the timeout after which the camera will be fixed to the selected point. Any attempt to pan the camera to another point will be failed when **GUARD** on the mobile app, EagleEyes, is enabled.

6.4.3 ALERT

ADVANCED CONFIG		
CAMERA	EXT. ALERT	ON
DETECTION	INT. BUZZER	OFF
ALERT	KEY BUZZER	ON
NETWORK	VLOSS BUZZER	ON
DISPLAY	MOTION BUZZER	ON
RECORD	ALARM BUZZER	ON
DEVICES	HDD BUZZER	ON
DCCS	ALARM DURATION (SEC)	5 ▼
IVS	HDD NEARLY FULL (GB)	5 ▼
NOTIFY	HDD OVERHEAT ALERT (°C)	60 ▼
JOYSTICK		
EXIT		

1) EXT. ALERT

Select to enable or disable the sound when any external alarm is triggered (**ON / OFF**).

2) INT. BUZZER

Select to enable or disable the sound (ON / OFF) for all internal buzzers: **KEY BUZZER, VLOSS BUZZER, MOTION BUZZER, ALARM BUZZER, and HDD BUZZER.**

Note: When this item is set to **OFF**, item 3) to item 7) will be disabled even though they are set to ON.

3) KEY BUZZER

Select to enable or disable the sound when pressing the buttons on the front panel (**ON / OFF**).

4) VLOSS BUZZER

Select to enable or disable the sound when video loss happened (**ON / OFF**).

5) MOTION BUZZER

Select to enable or disable the sound when any motion alarm is triggered (**ON / OFF**).

6) ALARM BUZZER

Select to enable or disable the sound when any internal alarm is triggered (**ON / OFF**).

7) HDD BUZZER

Select to enable or disable the sound (ON / OFF) when the HDD remaining capacity reaches to the value set in **HDD NEARLY FULL (GB)**.

8) ALARM DURATION (SEC)

Select the duration time for alarm buzzer in second (**5 / 10 / 20 / 40**).

9) HDD NEARLY FULL (GB)

If **HDD BUZZER** is enabled, select the duration time for buzzer notifications when the hard disk available capacity is 5/10/15/20 GB left.

10) HDD OVERHEAT ALERT (°C)

Select the temperature alert for your hard disk to be aware of the possible overheat of your hard disk.

6.4.4 NETWORK

NETWORK

- **WAN** is used to connect this recorder to Internet for remote access from anywhere as long as Internet access is available.
- **DDNS** is used when the Internet access is available.

Note: For more details about these two functions and network configurations, please get the setup manual from www.surveillance-download.com/user/network_setup/network_setup_recorder.pdf.

ADVANCED CONFIG	
CAMERA	WAN E-MAIL DDNS PROTOCOL EaZy
DETECTION	NETWORK TYPE STATIC ▼
ALERT	IP 192.168.001.010
NETWORK	GATEWAY 192.168.001.254
DISPLAY	NETMASK 255.255.255.000
RECORD	PRIMARY DNS 8.8.8.8
DEVICES	SECONDARY DNS 168.95.1.1
DCCS	PORT 80
IVS	CHECK INTERNET AVAILABILITY BY ADDRESS www.google.com
NOTIFY	ENABLE UPNP OFF
JOYSTICK	
EXIT	MAC: 00:0E:53:EC:A7:B4

E-MAIL

When this function is enabled and an event occurs, a html file including a link will be sent to the specified E-mail address. Click the link to access to this DVR and check the event recording.

ADVANCED CONFIG	
CAMERA	WAN E-MAIL DDNS PROTOCOL EaZy
DETECTION	SMTP SERVER Smtplib.gmail.com
ALERT	PORT 465
NETWORK	MAIL FROM manager@gmail.com
DISPLAY	SSL ENCRYPTION ON
RECORD	VERIFY PASSWORD ON
DEVICES	USER NAME manager@gmail.com
DCCS	PASSWORD ●●●●●●
IVS	
NOTIFY	
JOYSTICK	
EXIT	

- 1) SMTP SERVER
Enter the SMTP server address provided from your e-mail system supplier.
- 2) PORT
Enter the port number provided from your e-mail system supplier. If this column is left blank, the e-mail server will use port 25 to send e-mails.
- 3) MAIL FROM
Enter the email address which will be used to send Email notifications.
- 4) SSL ENCRYPTION
Select **ON** if your e-mail server is using SSL encryption to protect your e-mail content from unauthorized access.
- 5) VERIFY PASSWORD
Some mail servers are required to verify the password. Please enter the “user name” and “password”.

6) USER NAME / PASSWORD

Enter the “user name” and “password” to access the email address entered in **MAIL FROM** when **VERIFY PASSWORD** is set to **ON**.

PROTOCOL

ADVANCED CONFIG					
CAMERA	WAN	E-MAIL	DDNS	PROTOCOL	EaZy
DETECTION	TCP PAYLOAD LENGTH		8192		
ALERT	UDP PAYLOAD LENGTH		1200		
NETWORK					
DISPLAY					
RECORD					
DEVICES					
DCCS					
IVS					
NOTIFY					
JOYSTICK					
EXIT					

1) TCP PAYLOAD LENGTH / UDP PAYLOAD LENGTH

Configure the payload length from 100 ~ 10000.

The higher the value, the larger data packet is carried, and the longer time is needed for the video to display.

The lower the value, the less data packet is carried, and the more possibility you might see video lag.

EaZy

This function is used to connect this recorder to Internet by using EaZy Networking. For details, please refer to “APPENDIX 9 EAZY NETWORKING” at page 79.

ADVANCED CONFIG					
CAMERA	WAN	E-MAIL	DDNS	PROTOCOL	EaZy
DETECTION	ENABLE EAZY NETWORKING ON				
ALERT	 000E532B8613				
NETWORK					
DISPLAY					
RECORD					
DEVICES					
DCCS					
IVS					
NOTIFY					
JOYSTICK					
EXIT					

6.4.5 DISPLAY

ADVANCED CONFIG					
CAMERA	FULL SCREEN DURATION		03	▼	
DETECTION	QUAD SCREEN DURATION <i>(For selected models only)</i>		03	▼	
ALERT	CALL SCREEN DURATION <i>(For selected models only)</i>		03	▼	
NETWORK	HDD DISPLAY MODE		REMAINING SIZE ▼		
DISPLAY	DISPLAY OUTPUT		AUTO ▼		
RECORD	COMPOSITE OUTPUT		MAIN MONITOR		
DEVICES	CALL MONITOR PERMIT		ALL		
DCCS					
IVS					
NOTIFY					
JOYSTICK					
EXIT					

1) FULL SCREEN DURATION

Select the full screen dwell duration time in second (**03 / 05 / 10 / 15**).

- 2) QUAD SCREEN DURATION *(For selected models only)*
Select the quad screen dwell duration time in second (**03 / 05 / 10 / 15**).
- 3) CALL SCREEN DURATION *(For selected models only)*
Select the duration time in second for the call monitor function (**03 / 05 / 10 / 15**).
- 4) HDD DISPLAY MODE
Select **REMAINING SIZE** to show the remaining HDD capacity for recording, **REMAINING TIME** to show the remaining recording time, or **DAYS KEPT** to show how many recording data are saved in day.
- 5) DISPLAY OUTPUT
Select the display resolution you want. The default value is **AUTO**.

Note: To have the best image quality on your monitor, make sure (1) the selected DVR output resolution is supported by your monitor, and (2) the output settings on both the LCD monitor and DVR are consistent.

If the image is not positioned or scaled properly, please go to your monitor’s menu for adjustment. For details, please refer to the user manual of your monitor.

- 6) COMPOSITE OUTPUT
Specify how this port is used for video output: **MAIN MONITOR / CALL MONITOR**.
 - **MAIN MONITOR** is used for normal video display.
 - **CALL MONITOR** is used for sequence display. When this option is selected, go to “**CALL MONITOR PERMIT**” to choose the channel(s) you want for sequence display.
- 7) CALL MONITOR PERMIT
Select the channel(s) you want for sequence display when **CALL MONITOR** is selected in **COMPOSITE OUTPUT**.

6.4.6 RECORD

Note: Please DO NOT change the date or time of your DVR after the recording function is activated. Otherwise, the recorded data will be disordered and you will not be able to find the recorded file to backup by time search. If users change the date or time accidentally when the recording function is activated, it’s recommended to clear all HDD data, and start recording again.

ADVANCED CONFIG		
CAMERA	MANUAL RECORD	ON
DETECTION	EVENT RECORD	ON
ALERT	TIMER RECORD	ON
NETWORK	PRE-ALARM RECORD	ON
DISPLAY	OVERWRITE	ON
RECORD	KEEP DATA LIMIT (DAYS)	OFF ▼
DEVICES	RECORD CONFIG	SETUP
DCCS	SUBSTREAM RESOLUTION	CIF ▼
IVS		
NOTIFY		
JOYSTICK		
EXIT		

- 1) MANUAL RECORD
Set the manual recording function on / off.
- 2) EVENT RECORD
Set the event recording function on / off.
- 3) TIMER RECORD
Set the timer recording function on / off.

4) PRE-ALARM RECORD

Select to enable or disable the pre-alarm function (ON / OFF).

When pre-alarm and event recording functions are both activated, the DVR will record 8MB data before an alarm / motion event is triggered.

5) OVERWRITE

Select **ON** to overwrite previous recorded data in your hard disk when the hard disk is full. When this function is on and the hard disk is full, the DVR will clear 8GB data from the oldest for continuous recording without notice.

6) KEEP DATA LIMITS (DAYS)

Assign the maximum recording days from 1 to 31 after which all the recorded data will be removed, or select **OFF** to disable this function.

7) RECORD CONFIG

Click **SETUP** to enter the setting page individually for manual record, event record and timer record. For details, please refer to “6.1.1 GENERAL” at page 22.

8) SUBSTREAM RESOLUTION

Select the resolution for sub-streams: **FRAME / CIF**.

Sub-streams are used for remote surveillance from a PC or mobile device. When the bandwidth is low, choose a lower resolution helps to quickly view the video, but the video quality might get low.

6.4.7 DEVICES

Note: This function is used when the DVR supports RS485 connection, and you want to connect other brand’s speed dome camera.

ADVANCED CONFIG	
CAMERA DETECTION ALERT NETWORK DISPLAY RECORD DEVICES DCCS IVS NOTIFY JOYSTICK EXIT	CH1 CH2 CH3 CH4
	DEVICE PTZ ▼
	ID 00
	PROTOCOL NORMAL ▼
	RATE 2400 ▼
	INTERFACE RS485

1) DEVICE

For connecting other brand’s speed dome camera, select **PTZ**.

2) ID

Click the current value to set the ID number (0 ~ 255) for the connected camera if necessary.

Make sure the ID setting of the camera is the same as the setting here, or the DVR will not be able to control the device.

Note: To know the default ID of the speed dome camera, please refer to its user manual.

3) PROTOCOL

Select **NORMAL** (our protocol), **P-D** (PELCO-D), **P-P** (PELCO-P), **S-T** (SAMSUNG-T) or **S-E** (SAMSUNG-E) protocol.

4) RATE

Select the baud rate for the connected speed dome camera (**2400 / 4800 / 9600 / 19200 / 38400 / 57600 / 115200**).

Make sure the baud rate setting of the camera is the same as the setting here, or the DVR will not be able to control the device.

Note: To know the default baud rate of the speed dome camera, please refer to its user manual.

6.4.8 DCCS

This function is used for our brand's HD CCTV camera series. Users could access the setup menu of the camera itself for further configurations.

ADVANCED CONFIG	
CAMERA	CH1 CH2 CH3 CH4
DETECTION	DIAGNOSTIC START
ALERT	OSD MENU SETUP
NETWORK	
DISPLAY	
RECORD	
DEVICES	
DCCS	
IVS	DEVICE CAMERA
NOTIFY	CONNECTION UNKNOWN
JOYSTICK	
EXIT	

1) DIAGNOSTIC

When our brand's HD CCTV camera is connected, click **START** to ensure the DVR recognizes it. This function disappears when the DVR recognizes the camera properly.

2) OSD MENU

When the connected camera is properly recognized after **DIAGNOSTIC**, click **SETUP** to enter the setup page of the camera itself.

3) DCCS MENU

This menu appears when the camera is properly recognized after **DIAGNOSTIC**, and it is used to enter the additional function setup page designed for the connected camera.

Note: Functions additionally designed are not available for every HD CCTV camera.

6.4.9 IVS

Note: This function is for selected models only.

Note: Before using the IVS function, make sure the event record function is enabled on your DVR.

IVS, Intelligent Video Surveillance, is the advanced application for motion detection, but more precise and smarter. It can be applied to different situations with one of the following three modes: FLOW COUNTING, VIRTUAL FENCE, and ONE WAY.

When anyone crosses the detection line (virtual fence), the recording will be on.

Note: Four camera channels are supported for this function.

ADVANCED CONFIG			
CAMERA DETECTION ALERT NETWORK DISPLAY RECORD DEVICES DCCS IVS NOTIFY JOYSTICK EXIT	IVS1 IVS2 IVS3 IVS4	CAMERA IVS MODE DISPLAY LINE SENSITIVITY RESET COUNT VIRTUAL FENCE AREA SCENE CHANGE SCENE CHANGE LEVEL	CH3 FLOW COUNTING OFF 7 SUBMIT SETUP OFF MIDDLE

1) CAMERA

Select the camera channel that you want to use the IVS function.

2) IVS MODE

Select one of the following three modes depending on your environment:

MODE	DESCRIPTION
FLOW COUNTING	A virtual detection line is set to detect the moving direction of pedestrians for flow counting.
VIRTUAL FENCE	A virtual detection line is set to detect intruders crossing the detection line, and an alarm will be triggered.
ONE WAY	A virtual detection line is set to detect intruders from the specified direction, and an alarm will be triggered.

3) DISPLAY LINE

Select to display the detection line for IVS on the screen or not.

4) SENSITIVITY

Set the sensitivity for IVS from 00 ~ 15. The larger the value, the more sensitive the IVS will be.

5) RESET COUNT



Click **SUBMIT** to reset the flow counting number to 0 when the IVS mode is set to **FLOW COUNTING** and activated.

6) VIRTUAL FENCE AREA

Click **SETUP** to draw the detection line for IVS, and set the detection direction from left to right, or right to left. This area setting is the detection base for **IVS MODE**.

Note: There are some tips to draw the detection line. For details, please check www.surveillance-download.com/user/IVS_setup.pdf.

7) SCENE CHANGE

Select **ON** to trigger a motion event when the camera is sensed to be moved and the camera scene is changed. At the same time, the icon "" will be also shown on the screen in addition to the motion icon ".

8) SCENE CHANGE LEVEL

Set the detection sensitivity for **SCENE CHANGE** to **HIGH**, **MIDDLE** or **LOW**.

IVS APPLICATION

➤ **FLOW COUNTING**

Step1: Go to **VIRTUAL FENCE AREA** to draw a detection line with your mouse, and decide the detection direction by selecting **REVERSE**.



Step2: Click **APPLY** to finish the IVS setting and return to the live view. The IVS icon “” will be shown on the status bar. Click it to show the flow counting on the top left side.

When anyone walks across the detection line, the system will determine his movement is in or out, and add one count to the corresponding channel on the flow counting panel.

IN	People coming from the opposite direction to the arrow mark.
OUT	People coming from the same direction as the arrow mark.





➤ **VIRTUAL FENCE and ONE WAY**

Step1: Go to **VIRTUAL FENCE AREA** to draw a detection line with your mouse, and decide the detection direction by selecting **REVERSE**.





Step2: Click **APPLY** to finish the IVS setting and return to the live view.

When anyone walks across the detection line, the system will determine his movement is in or out, and:

VIRTUAL FENCE	An event happens for anyone walking across the detection line, and “  ” will be shown on the screen.
ONE WAY	An event happens for anyone walking from the opposite direction to the arrow mark, and “  ” will be shown on the screen.



IVS STATISTICS

Click “” → “” to enter the event search menu. Then, select **STATISTIC**

LIST																													
QUICK SEARCH RECORD MOTION ALARM TIME SYSTEM HUMAN DETECTION IVS FULL STATISTIC	<table border="1"> <tr> <td>CHANNEL</td> <td>3 SELECTED ▲</td> </tr> <tr> <td><input type="checkbox"/></td> <td>ALL</td> </tr> <tr> <td><input checked="" type="checkbox"/></td> <td>CH1</td> </tr> <tr> <td><input checked="" type="checkbox"/></td> <td>CH2</td> </tr> <tr> <td><input checked="" type="checkbox"/></td> <td>CH3</td> </tr> <tr> <td><input type="checkbox"/></td> <td>CH4</td> </tr> <tr> <td><input type="checkbox"/></td> <td>CH5</td> </tr> </table> <table border="1"> <tr> <td>EVENT TYPE</td> <td>3 SELECTED ▲</td> </tr> <tr> <td><input type="checkbox"/></td> <td>ALL</td> </tr> <tr> <td><input checked="" type="checkbox"/></td> <td>INFLOW</td> </tr> <tr> <td><input checked="" type="checkbox"/></td> <td>OUTFLOW</td> </tr> <tr> <td><input checked="" type="checkbox"/></td> <td>VIRTUAL FENCE</td> </tr> <tr> <td><input type="checkbox"/></td> <td>ONEWAY</td> </tr> <tr> <td><input type="checkbox"/></td> <td>MOTION</td> </tr> </table> TIME 2010/MAY/17 STATISTIC SUBMIT	CHANNEL	3 SELECTED ▲	<input type="checkbox"/>	ALL	<input checked="" type="checkbox"/>	CH1	<input checked="" type="checkbox"/>	CH2	<input checked="" type="checkbox"/>	CH3	<input type="checkbox"/>	CH4	<input type="checkbox"/>	CH5	EVENT TYPE	3 SELECTED ▲	<input type="checkbox"/>	ALL	<input checked="" type="checkbox"/>	INFLOW	<input checked="" type="checkbox"/>	OUTFLOW	<input checked="" type="checkbox"/>	VIRTUAL FENCE	<input type="checkbox"/>	ONEWAY	<input type="checkbox"/>	MOTION
CHANNEL	3 SELECTED ▲																												
<input type="checkbox"/>	ALL																												
<input checked="" type="checkbox"/>	CH1																												
<input checked="" type="checkbox"/>	CH2																												
<input checked="" type="checkbox"/>	CH3																												
<input type="checkbox"/>	CH4																												
<input type="checkbox"/>	CH5																												
EVENT TYPE	3 SELECTED ▲																												
<input type="checkbox"/>	ALL																												
<input checked="" type="checkbox"/>	INFLOW																												
<input checked="" type="checkbox"/>	OUTFLOW																												
<input checked="" type="checkbox"/>	VIRTUAL FENCE																												
<input type="checkbox"/>	ONEWAY																												
<input type="checkbox"/>	MOTION																												
EXIT																													

Set all the criteria you want to search, and click **SUBMIT** in **STATISTIC** to show the event statistics by **DAY** in **LIST** (default) or **CHART**.

- To check the statistics in the bar chart, click **CHART**.
- To switch to the **MONTH** or **HOUR** view, click **DAY** at the bottom.

List View

IVS STATISTIC			
LIST	CHART		▲
HOUR		COUNT	
00:00 – 00:59		0	
01:00 – 01:59		0	
02:00 – 02:59		0	
03:00 – 03:59		0	
04:00 – 04:59		0	
05:00 – 05:59		10	
06:00 – 06:59		0	
07:00 – 07:59		0	
08:00 – 08:59		5	
09:00 – 09:59		0	▼
2010/MAY/17		BACKUP	DAY EXIT

Chart View

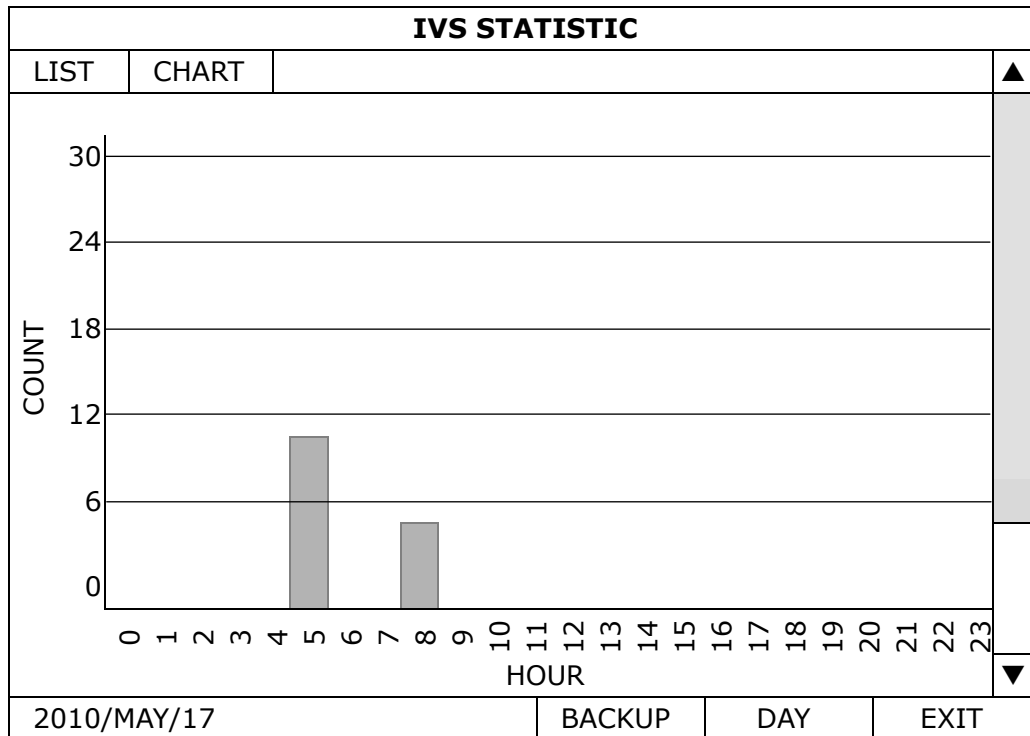

6.4.10 NOTIFY

You can configure this DVR to send notifications for certain events to mobile devices with our mobile app, EagleEyes, installed, or to the specified E-mail address(es) or FTP site.

PUSH VIDEO

Note: This function is for selected models only.

Before using this function, make sure:

- An external alarm is connected to the alarm-in port on the rear panel.
- You have an iOS or Android mobile phone or tablet.
- You have subscribed the mobile network service from your mobile service provider.
- The mobile app, EagleEyes, is installed in your mobile device. For details, please refer to “7.2 Mobile Devices” at page 61.
- You have configured EagleEyes to access this DVR, and **Guard** is enabled. For details, please refer to “APPENDIX 3 SET PUSH VIDEO” at page 71.

You’ll get an active event notification with video telling you the occurrence of alarm event(s).

ADVANCED CONFIG					
CANERA DETECTION ALERT NETWORK DISPLAY RECORD DEVICES DCCS IVS NOTIFY JOYSTICK	<input type="checkbox"/> PUSH VIDEO	<input type="checkbox"/> PUSH STATUS	<input type="checkbox"/> MESSAGE MAIL	<input type="checkbox"/> MAIL	<input type="checkbox"/> FTP
	RESET ALL GUARD CONNECTION				SUBMIT
	GUARD TRIGGER BY				<input type="text" value="ALARM IN 1"/>
	CH01	<input type="text" value="ALARM OFF / INTERNAL ALARM"/>	<input type="text" value="CH1"/>		
	CH02	<input type="text" value="ALARM OFF"/>	<input type="text" value="CH2"/>		
	CH03	<input type="text" value="ALARM N.O."/>	<input type="text" value="office"/>		
	CH04	<input type="text" value="ALARM OFF"/>	<input type="text" value="CH4"/>		
	<input type="button" value="EXIT"/>				

1) RESET ALL GUARD CONNECTION

When there’re more than 2 users who have the authority to enable Push Video on their mobile devices and configure its related settings, it might be confusing to know whose command is working. In this case, use this function could force the camera to discard all Push Video setup and reconfigure it.

2) GUARD TRIGGER BY

Specify which alarm device (alarm-in) should be used when **GUARD** is enabled from your iOS or Android mobile device.

3) ALARM TYPE

Select the external alarm type to **ALARM NO.**, **ALARM N.C.** and **INTERNAL ALARM**.

4) CH01 ~ 04

Enter the text you want to see when your iOS or Android mobile device receives Push Video. The default text is the channel number.

PUSH STATUS

Before using this function, make sure:

- You have an iOS or Android mobile phone or tablet.
- You have subscribed the mobile network service from your mobile service provider.
- The mobile app, EagleEyes, is installed in your mobile device. For details, please refer to “7.2 Mobile Devices” at page 61.
- You have configured EagleEyes to access this DVR, and **Guard** is enabled. For details, please refer to “APPENDIX 3 SET PUSH VIDEO” at page 71.

You'll get a text message telling you the occurrence of selected system event(s).

ADVANCED CONFIG					
CANERA DETECTION ALERT NETWORK DISPLAY RECORD DEVICES DCCS IVS NOTIFY JOYSTICK	PUSH VIDEO	PUSH STATUS	MESSAGE MAIL	MAIL	FTP
	ACTION	ON			
	EVENT	<input type="checkbox"/> ALL <input checked="" type="checkbox"/> VIDEO LOSS <input type="checkbox"/> HDD FULL <input type="checkbox"/> POWER ON <input checked="" type="checkbox"/> HDD (CLEAR / NO HDD / OVER TEMPERATURE) <input type="checkbox"/> NET LOGIN <input checked="" type="checkbox"/> KEY UNLOCK <input type="checkbox"/> UPS <input type="checkbox"/> SYSTEM ABNORMAL			
EXIT					

Step1: Switch **ACTION** to **ON**.

Step2: Select the system event(s) you want to get notified via your mobile device.

Step3: Enable **GUARD** in EagleEyes on your mobile device, and try to trigger a system event to see if you'll get Push Status.

MESSAGE MAIL

Note: For E-mail notifications, make sure you have configured an E-mail account in **NETWORK** → **E-MAIL** to send the notifications.

Enable this function in **ACTION**, select the event type(s) you want to send notifications in **EVENT**, and add the E-mail address(es) to which you want to send notifications in **RECEIVER**.

You'll get an E-mail telling you the occurrence of your selected event(s).

ADVANCED CONFIG					
CANERA DETECTION ALERT NETWORK DISPLAY RECORD DEVICES DCCS IVS NOTIFY JOYSTICK	PUSH VIDEO	PUSH STATUS	MESSAGE MAIL	MAIL	FTP
	ACTION		ON		
EVENT		<input type="checkbox"/> ALL			
		<input checked="" type="checkbox"/> VIDEO LOSS			
		<input type="checkbox"/> HDD FULL			
		<input type="checkbox"/> POWER ON			
		<input checked="" type="checkbox"/> HDD (CLEAR / NO HDD / OVER TEMPERATURE)			
		<input type="checkbox"/> NET LOGIN			
		<input checked="" type="checkbox"/> KEY UNLOCK			
		<input type="checkbox"/> NETWORK			
		<input type="checkbox"/> UPS			
		<input type="checkbox"/> SYSTEM ABNORMAL			
RECEIVER		SETUP			
EXIT					

MAIL

Note: For E-mail notifications, make sure you have configured an E-mail account in **NETWORK** → **E-MAIL** to send the notifications.

ADVANCED CONFIG					
CANERA DETECTION ALERT NETWORK DISPLAY RECORD DEVICES DCCS IVS NOTIFY JOYSTICK	PUSH VIDEO	PUSH STATUS	MESSAGE MAIL	MAIL	FTP
	E-MAIL BY EVENT			ON	
	E-MAIL BY GUARD			ON	
	RECEIVER			SETUP	
	CONTENT TYPE			AVI	▼
EXIT					

- 1) E-MAIL BY EVENT
Select to receive email notifications when any event occurs.
- 2) E-MAIL BY GUARD
Select to receive email notifications only when Push Video and Push Status events occur.
- 3) RECEIVER
Click "Setup" to enter the email address(es) of the person(s) to receive email notifications.
- 4) CONTENT TYPE
Select which type of notifications you want to receive: **LINK**, **AVI** or **JPEG**.
 - For **LINK**, you'll receive an html file. For details, please refer to the next section "How to check video footage by LINK".
 - For **AVI**, you'll receive a file of video footage in the "AVI" format.
 - For **JPEG**, you'll receive a snapshot in the "JPEG" format.

How to check video footage by “LINK”

Step1: Open the html file received.

Note: Please accept and install ActiveX control on your computer. It’s recommended to use Internet Explorer to open the HTML file.

Step2: Enter the user name and password to log into this DVR, and select the channel you want.

Step3: Click **Open** to download the footage to your computer and play.

Note: The footage download and playback will be failed if either of your DVR and PC is not connected to Internet.

The screenshot shows a web interface for a DVR. At the top, there are input fields for 'User Name' (containing 'admin'), 'Password' (masked with dots), 'Channel' (set to '1'), 'Start Time' (2012/01/18 15:04:54), and 'End Time' (2012/01/18 15:05:05). An 'Open' button is to the right. Below these fields is a video player showing an aerial view of a street intersection. Above the video, text reads 'DATE TIME: 2012/01/18 15:04:56 Direction: FORWARD Speed: Normal DATA LOAD: 19% / PLAY LOAD: 96%'. Below the video is a playback control panel with buttons for 'Play', 'Pause', 'Stop', 'Rewind', 'Fast', and a 'Deinterlace' checkbox. Red annotations highlight the login fields, the 'Open' button, and the playback controls.

FTP

ADVANCED CONFIG					
CAMERA	PUSH VIDEO	PUSH STATUS	MESSAGE MAIL	MAIL	FTP
DETECTION	UPLOAD BY EVENT				ON
ALERT	UPLOAD BY GUARD				ON
NETWORK	USER NAME				office
DISPLAY	PASSWORD				●●●●●●●●
RECORD	SERVER				211.75.33.2144
DEVICES	PORT				25
DCCS	DIRECTORY				video
IVS	CONTENT TYPE				AVI ▼
NOTIFY					
JOYSTICK					
EXIT					

1) UPLOAD BY EVENT

Select to get event notifications uploaded when any event occurs.

2) UPLOAD BY GUARD

Select to get event notifications uploaded only when Push Video and Push Status events occur.

3) USER NAME / PASSWORD / SERVER / PORT / DIRECTORY

Enter the information needed for FTP uploading.

4) CONTENT TYPE

Select which type of notifications you want to receive: **LINK**, **AVI** or **JPEG**.

- For **LINK**, you'll receive an html file. For details, please refer to the next section "How to check video footage by LINK".
- For **AVI**, you'll receive a file of video footage in the "AVI" format.
- For **JPEG**, you'll receive a snapshot in the "JPEG" format.

How to check video footage by "LINK"

Step1: Open the html file received.

Note: Please accept and install ActiveX control on your computer. It's recommended to use Internet Explorer to open the HTML file.

Step2: Enter the user name and password to log into this DVR, and select the channel you want.

Step3: Click "Open" to download the footage to your computer and play.

Note: The footage download and playback will be failed if either of your DVR and PC is not connected to Internet.

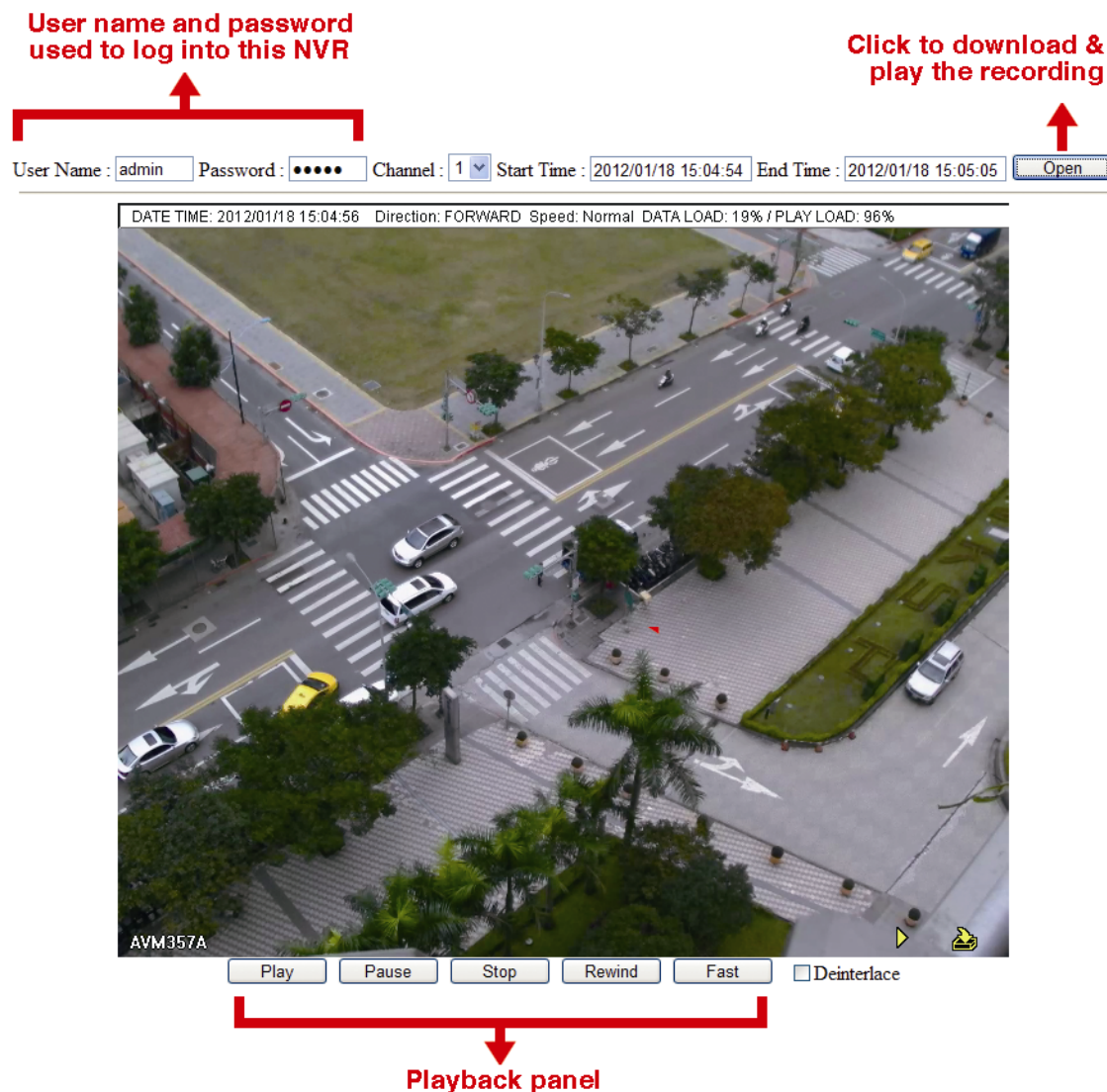

6.4.11 JOYSTICK

In this menu, you can adjust the speed of pan / tilt movement of the speed dome camera or a motorized-pan camera.

Note: To control the movement of the speed dome camera, you can choose  from the PTZ control panel and move on the screen ("5.3 PTZ Control" at page 17), or simply connect the compatible joystick, AVX102, to the DVR.

ADVANCED CONFIG	
CONNECTION	
CAMERA	
DETECTION	
ALERT	
NETWORK	
DISPLAY	
RECORD	
NOTIFY	
MULTICASTING	
JOYSTICK	
EXIT	

MAX SPEED OF X AXIS	<input type="text" value="100"/>
MAX SPEED OF Y AXIS	<input type="text" value="100"/>
CURVE ORDER OF X AXIS	1
CURVE ORDER OF Y AXIS	1

6.5 SCHEDULE SETTING

6.5.1 RECORD / DETECTION / ALARM IN / ALARM OUT / PUSH VIDEO / BUZZER

Select the timer type you want to configure (**RECORD / DETECTION / ALARM IN / ALARM OUT / PUSH VIDEO / BUZZER**), choose **ON** to enable the timer, and select the day and time for this function.

Note: Push Video is available for selected models only.

Note: The selected time bar is marked as blue.

SCHEDULE SETTING	
RECORD	RECORD TIMER ON
DETECTION	0 2 4 6 8 10 12 14 16 18 20 22 24
ALARM IN	SUN
ALARM OUT	MON
PUSH VIDEO	TUE
BUZZER	WED
REGULAR REPORT	THU
AUTO BACKUP	FRI
REGULAR REBOOT	SAT
EXIT	

X axis 0 ~ 24 hours. Each time bar is 30 minutes.

Y axis Monday ~ Sunday.

6.5.2 REGULAR REPORT

This function is used to send event reports to the specified E-mail address. Users could configure up to 5 profiles to receive different reports about specific channels at different time.

Note: This function is available only when a hard disk is installed, and the DVR is connected to Internet.

SCHEDULE SETTING		
RECORD	PROFILE	1 ▼
DETECTION	ACTIVE	ON
ALARM IN	EXECUTION PERIOD	MONTHLY ▼
ALARM OUT	EXECUTION DAY OF MONTH	1
PUSH VIDEO	EXECUTION HOUR	1 ▼
BUZZER	CHANNEL	CH1 ▼
REGULAR REPORT	EVENT TYPE	MOTION ▼
AUTO BACKUP	E-MAIL	SETUP
REGULAR REBOOT		
EXIT		

Step1: Select the profile you want to configure, and enable it.

Step2: Select the frequency to send reports in **PERIOD: DAILY / MONTHLY / WEEKLY.**

Step3: When **MONTHLY** or **WEEKLY** is selected, select which date or day from **EXECUTION DAY OF MONTH** or **EXECUTION DAY OF WEEK.**

Step4: Then, select which time you want to receive reports, which channel(s) you want to see, and which event type(s) you want to see (**MANUAL / MOTION / ALARM / SYSTEM / TIMER / HUMAN DETECTION / INFLOW / OUTFLOW / VIRTUAL FENCE / ONEWAY / SCENE CHANGE**).

Step5: Configure the email address to receive reports.

Note: The sender E-mail should be configured in **ADVANCED CONFIG → NETWORK → E-MAIL** for this function to work properly. For details, please refer to "E-MAIL" at page 39.

6.5.3 AUTO BACKUP

This function is used to schedule video backup regularly, uploading security footages to a FTP site (remotely) or saving to an USB device connected to the DVR (locally).

You can configure up to 7 profiles and use one of them as your backup preference.

SCHEDULE SETTING		
RECORD	PROFILE	1 ▼
DETECTION	ACTIVE	ON
ALARM IN	FTP USER NAME	Office
ALARM OUT	FTP PASSWORD	●●●●●●●●
PUSH VIDEO	FTP PORT	25
BUZZER	FTP SERVER	211.75.33.2144
REGULAR REPORT	FTP DIRECTORY	Video
AUTO BACKUP	METHOD	FTP ▼
REGULAR REBOOT	VIDEO	ALL ▼
	AUDIO	2 SELECTED ▼
	VIDEO SOURCE	RECORD STREAM ▼
	EXECUTION PERIOD	WEEKLY ▼
	EXECUTION DAY OF WEEK	MON ▼
	EXECUTION HOUR	23 ▼
	BACKUP START DAY OF WEEK	MON ▼
	BACKUP START TIME	23:00
	BACKUP END DAY OF WEEK	MON ▼
	BACKUP END TIME	23:00
EXIT		

- 1) PROFILE
Select the profile you want to configure.
- 2) ACTIVE
Switch to ON to enable the selected profile.
- 3) FTP USER NAME / FTP PASSWORD / FTP PORT / FTP SERVER / FTP DIRECTORY
Enter all the information needed to access the FTP site you want if you want to upload those footages to an FTP site.
- 4) METHOD
Choose where you to save those footages: **FTP / USB DEVICE**.
- 5) VIDEO / AUDIO
Select the video / audio channels you want to backup.
- 6) VIDEO SOURCE
Choose **RECORD STREAM** or **SUB STREAM**:
 - **RECORD STREAM**: The video quality is good, but it also consumes much storage.
 - **SUB STREAM**: It consumes less storage, but the video quality might be not satisfactory.
- 7) EXECUTION PERIOD
Select how often you want to backup footages: **WEEKLY** or **DAILY**.
- 8) EXECUTION DAY OF WEEK
This option is available only when **WEEKLY** is chosen. Select one day from **MON ~ SUN**.
For example, if you want to backup video data from Monday, 01:00am to Friday, 23:59pm on every Saturday, 09:00am, choose SAT here.
- 9) EXECUTION HOUR
Select an exact hour to start rebooting from **0 ~ 23**.
For example, if you want to backup video data from Monday, 01:00am to Friday, 23:59pm on every Saturday, 09:00am, choose 9 here.
- 10) BACKUP START DAY OF WEEK
This option is available only when **WEEKLY** is chosen. Select one day from **MON ~ SUN**.
For example, if you want to backup video data from Monday, 01:00am to Friday, 23:59pm on every Saturday, choose MON here.
- 11) BACKUP START TIME
Enter the start time for backup.
For example, if you want to backup video data from Monday, 01:00am to Friday, 23:59pm on every Saturday, enter 01:00 here.
- 12) BACKUP END DAY OF WEEK
This option is available only when **WEEKLY** is chosen. Select one day from **MON ~ SUN**.
For example, if you want to backup video data from Monday, 01:00am to Friday, 23:59pm on every Saturday, choose FRI here.
- 13) BACKUP END TIME
Enter the end time for backup.
For example, if you want to backup video data from Monday, 01:00am to Friday, 23:59pm on every Saturday, enter 23:59 here.

6.5.4 REGULAR REBOOT

This function is used to schedule this device to reboot regularly to free some unused cache data and make the system more reliable.

SCHEDULE SETTING									
<p>RECORD DETECTION ALARM IN ALARM OUT PUSH VIDEO BUZZER REGULAR REPORT AUTO BACKUP REGULAR REBOOT</p>	<table style="width: 100%;"> <tr> <td style="width: 50%;">ACTIVE</td> <td style="width: 50%;">ON</td> </tr> <tr> <td>EXECUTION PERIOD</td> <td>MONTHLY ▼</td> </tr> <tr> <td>EXECUTION DAY OF MONTH</td> <td>1 ▼</td> </tr> <tr> <td>EXECUTION HOUR</td> <td>1 ▼</td> </tr> </table>	ACTIVE	ON	EXECUTION PERIOD	MONTHLY ▼	EXECUTION DAY OF MONTH	1 ▼	EXECUTION HOUR	1 ▼
ACTIVE	ON								
EXECUTION PERIOD	MONTHLY ▼								
EXECUTION DAY OF MONTH	1 ▼								
EXECUTION HOUR	1 ▼								
EXIT									

2) ACTIVE

Switch to ON to enable this function.

3) EXECUTION PERIOD

Select how often you want to reboot the system: **MONTHLY**, **WEEKLY** or **DAILY**.

4) EXECUTION DAY OF MONTH / EXECUTION DAY OF WEEK

Depending on the option you selected in **EXECUTION PERIOD**:

- **EXECUTION DAY OF MONTH** shows when **MONTHLY** is selected. Select one day from 1 ~ 31 to reboot.
- **EXECUTION DAY OF WEEK** shows when **WEEKLY** is selected. Select one day from Monday ~ Sunday to reboot.

5) EXECUTION HOUR

Select an exact hour to start rebooting from **0** ~ **23**.

7. REMOTE OPERATION

7.1 Web Browser

You can view the images or operate your DVR with a web browser, for example, Microsoft Internet Explorer.

Note: The supported PC operating systems are Windows 10, Windows 8, Windows 7, Windows Vista & Windows XP.

Note: To use Mozilla Firefox or Google Chrome for remote access, please go to Apple’s official website (<http://www.apple.com>) to download and install QuickTime first.

Note: The illustration below is just for your reference and may be different from what you actually see. Some functions and buttons are for selected models or certain user levels only.

Step 1: Key in the IP address used by this device in the URL address box, such as 60.121.46.236, and press Enter. You will be prompted to enter the user name and password to access the device.

If the port number this device used is NOT 80, you need to key in the port number additionally. The format is **ipaddress:portnum**.







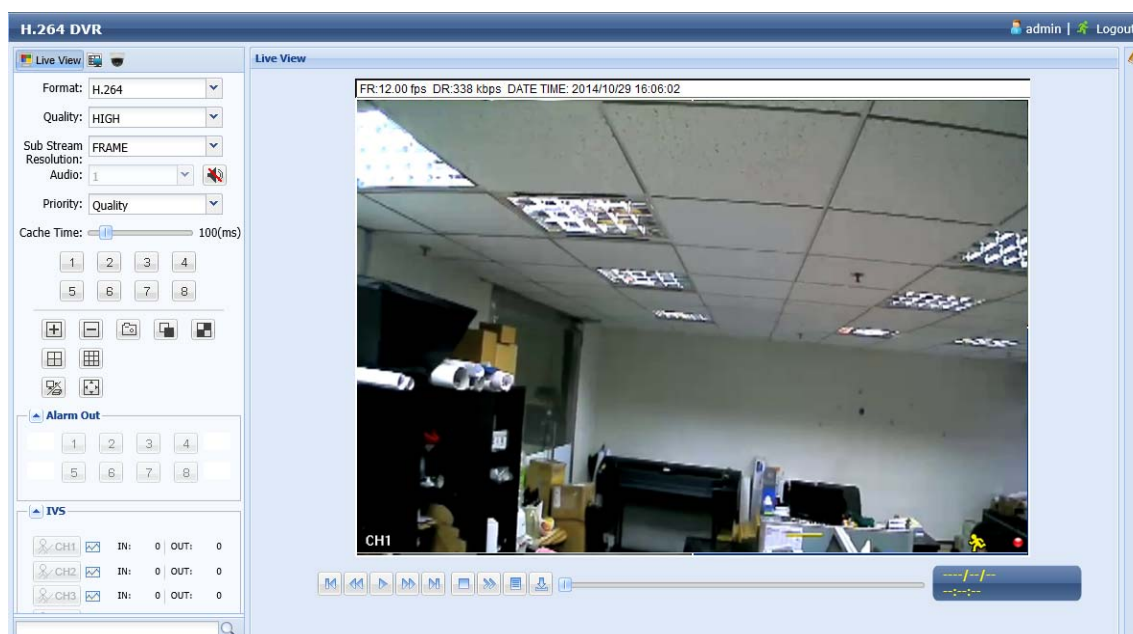















For example, for the IP address 60.121.46.236 and port No. 888, please key in "http://60.121.46.236:888" into the URL address box, and press **Enter**.

Step 2: Enter the user name and password, and click **OK**. You will see a similar screen as the following when the login information is correct.

Note: The default user name and password for remote access are both **admin**.



Icon	Description
	Click to go to the live view of the DVR.
	Click to go to the detailed DVR setting.
	Click to enter the PTZ mode. This function is also used for our band’s HD CCTV motorized camera series to adjust its focal length and focus remotely. For details, please refer to “7.1.2 PTZ Panel” at page 60.
Video / Audio Control	
Format	H.264 / QuickTime QuickTime is Apple Inc.’s multimedia software. You need to have QuickTime installed in you operation system first. When “QuickTime” is selected, you will be promoted to enter the user name and password to access the server of the DVR.
Quality	BEST / HIGH / NORMAL / BASIC Select the image quality.
Sub Stream Resolution	FRAME / CIF Select the sub stream resolution (FRAME: 704*480 / CIF: 352*240) for live display.

Icon	Description
Audio	<p>Select the audio channel you want for listening to the live audio.</p> <p>Note: Your camera must support audio recording, and connect to the video channel which supports audio recording and the audio input of the DVR. For details, please refer to "1.3 Rear Panel" at page 2.</p> <p> means mute.</p> <p>To disable the mute status, click this icon again and select the audio channel you want.</p>
Priority*	<p>Quality / Frame rate</p> <p>This function is used to choose the live display priority between Quality and Frame rate.</p> <p>When "Quality" is chosen, the video quality goes up but the display will get lagged.</p> <p>When "Frame rate" is chosen, the display is fluent but the video quality will go down.</p>
Streaming	<p>This function shows only when a single channel is selected. Choose the stream resolution for live display.</p> <p>When Sub Stream is selected, the resolution will be the one selected in Sub Stream Resolution; When Recording is selected, the resolution will be the one selected in  -> "DVR" -> "Record" -> "Manual".</p>
Cache Time	<p>Select the cache time from 0 ~ 800ms.</p> <p>The higher the value, the more time it's going to be needed to wait for the image to show, but the better the image quality will be.</p>
Channel Control	
Channel Selection (1 ~ 16 / 1 ~ 8 / 1 ~ 4)	Click one of the numbers to switch to the channel you want to see in full screen.
	Click to go to the previous / next channel, or change setting.
	Click to take a snapshot of the current view, and save it to the specified path in your PC set in  -> "General".
	<p>: Click to display each channel one by one, starting from CH1. When the last channel is displayed, it will start from CH1 again.</p> <p>: To exit from this display mode, press any other channel display button.</p>
	Click to show 4-cut / 9-cut / 16-cut display.
	Click to enable local desktop display remotely. An individual window will pop up to show the local view. All operations available at the local side could be done independently and remotely in this window.
	Click to switch the display to full screen.
Event Search & Playback	
	Increase the speed for fast rewind. Click once to get 4X speed rewind and click twice to get 8X speed, etc., and the maximum speed is 32X.
	Increase the speed for fast forward. Click once to get 4X speed forward and click twice to get 8X speed, etc., and the maximum speed is 32X.
	Click to play the current video clip.
	Click to pause the video playback.
	Click to stop the video playback.
	Click to play the video clip slowly, once to get 4X slower, twice get 8X slower.
	Click to enter the record list and search and footage you need.
	<p>Click to enter the backup menu and copy the footage you need to your PC.</p> <p>Note: To play the backup file (.avc), go to  -> General -> Configure, and download the player to install.</p>
Alarm Out*	
Channel Selection (1 ~ 8 / 1 ~ 4)	Click one of the channel numbers to command the camera to trigger the alarm-out device you want.
IVS Panel*	
	This button is enabled only when the IVS mode is enabled. Click to show the detection line.
	Click to enter the IVS statistics page. For details, please refer to "7.1.1 IVS Statistics" at page 59.

* For selected models only

7.1.1 IVS Statistics

Note: This function is for selected models only.

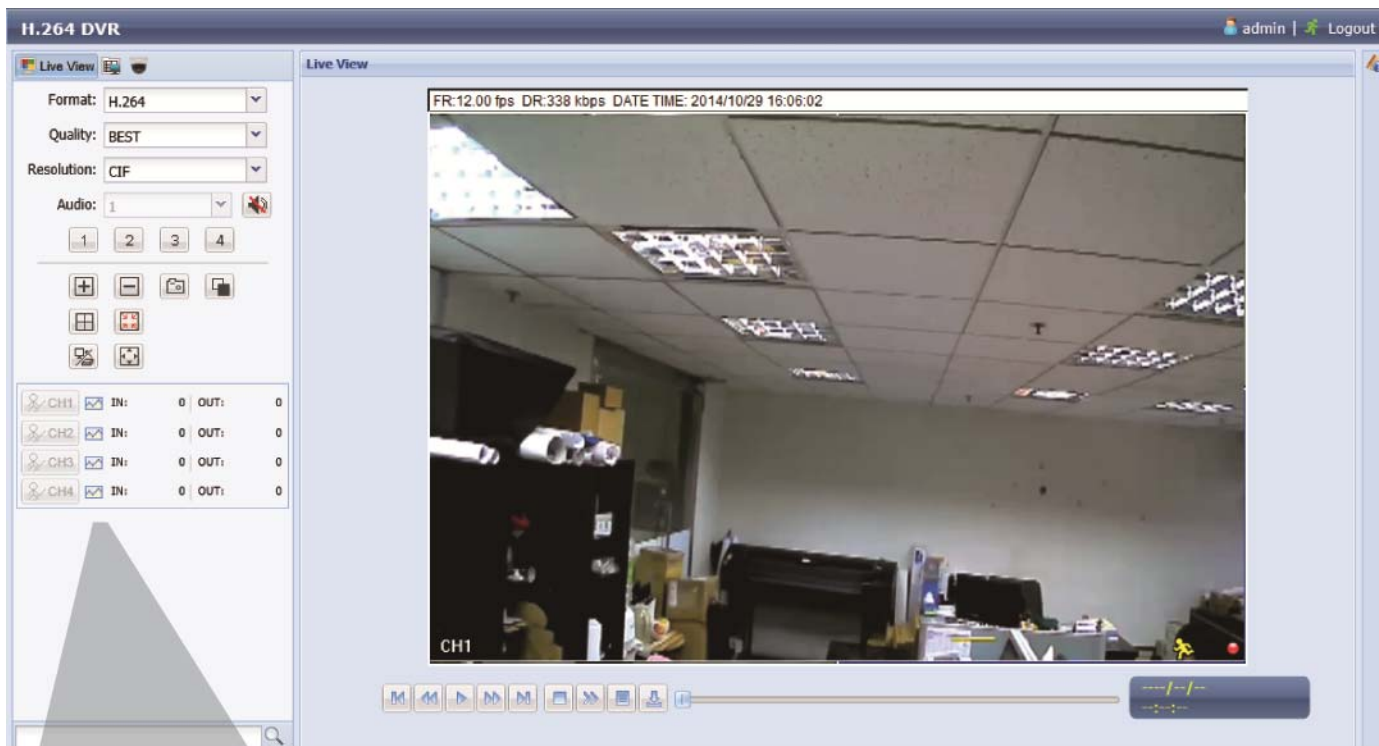

IVS Statistics

IVS Statistics: Event Search Panel

IVS Statistics: List

Hour	Count
2014 / 11 / 07 00:00 - 01:00	0
2014 / 11 / 07 01:00 - 02:00	0
2014 / 11 / 07 02:00 - 03:00	0
2014 / 11 / 07 03:00 - 04:00	0
2014 / 11 / 07 04:00 - 05:00	0
2014 / 11 / 07 05:00 - 06:00	0
2014 / 11 / 07 06:00 - 07:00	0
2014 / 11 / 07 07:00 - 08:00	0
2014 / 11 / 07 08:00 - 09:00	0
2014 / 11 / 07 09:00 - 10:00	0

Click to backup the log file in a .dat format which can be opened with Notepad.

Click to switch between the Day / Month / Year view

IVS Statistics: Chart







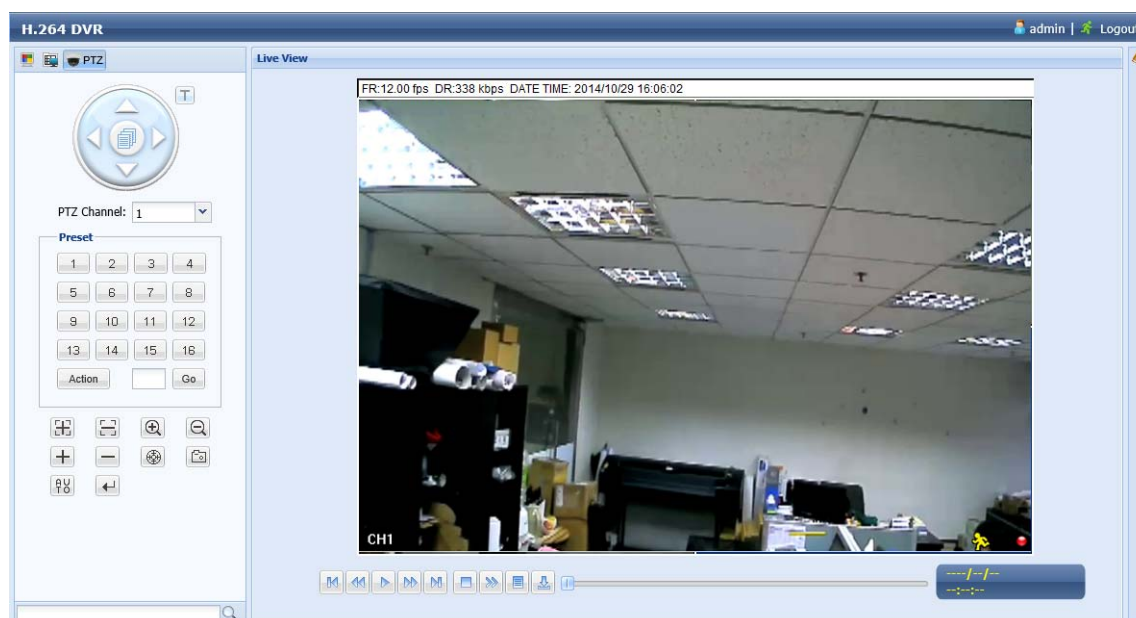

Click to backup the log file in a .dat format which can be opened with Notepad.

Click to switch between the Day / Month / Year view

7.1.2 PTZ Panel

Note: This function is for selected models only.



Function	Description
	Click to enter the camera main menu. For details about each camera menu, please refer to its own user manual.
	Click the arrow keys (▲ / ▼ / ◀ / ▶) to move the camera lens up / down / left / right.
PTZ Channel	Select the channel which connects the PTZ camera or our brand's HD CCTV motorized camera you want to control.
Preset	Click on the preset point numbering to which you want your camera to move.
	Click to adjust the focus of the image.
	Click to zoom in / out the image.
	Click to zoom in on the image to the largest / zoom out on the image to its original size.
	Click to start auto tracking when your speed dome camera supports this function.
	Click to take a snapshot of the current view, and save it to the specified path in your PC set in  → General .
	Click to activate the auto function. Before using it, you need to assign a specific function that will be enabled when "AU TO" is clicked. For details, please refer to the user manual of your PTZ camera or our brand's HD CCTV motorized camera.

7.2 Mobile Devices

Note: For more details about mobile surveillance via your mobile device, download the instructions of EagleEyes installation and configuration from www.surveillance-download.com/user/eagleeyes_quick.pdf.

EagleEyes is a mobile phone program used with our surveillance system for remote surveillance. It has several advantages:

- It's free (Except *EagleEyes Plus* for iPhone, *EagleEyes Plus+* for Android, and *EagleEyesHD Plus* for iPad).
- It's compatible with several popular mobile platforms, such as iOS and Android.

7.2.1 Prerequisites

Before installing EagleEyes to your mobile device for remote surveillance, make sure you have checked the following:

- ✓ Your mobile platform is iOS or Android.
- ✓ Mobile Internet services are subscribed and available to use for your mobile device.

Note: You might be charged for Internet access via the wireless or 3G network. For the Internet access rate details, please check with your local network operator or service provider.

- ✓ You have noted down the IP address, port number, user name and password used to access your network camera from Internet.

7.2.2 Where to download

- For iOS users, please go to "App Store", and search "EagleEyes" to download.
- For Android users, please go to "Play Store", and search "EagleEyes" to download.

When the download is completed, *EagleEyes* will be installed automatically to the location where all applications are saved in your phone by default, or where you specify.

7.2.3 Manual Setup

Note: To know how to configure by EaZy Networking, please refer to "APPENDIX 8 EAZY NETWORKING" at page 79.

Step1: Open EagleEyes to go to the address book.

Step2: Then, click **+**, and select **Manual** to go to the setting page.

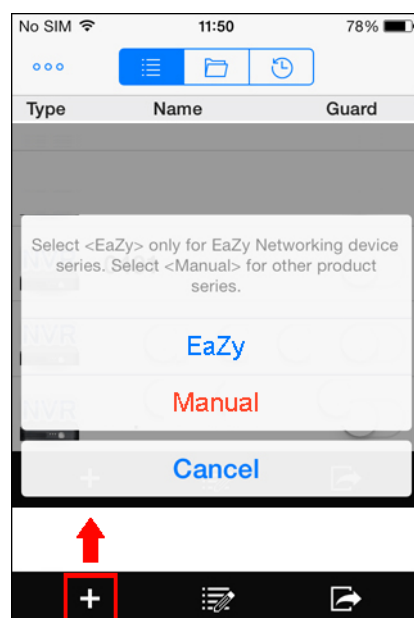

Step3: In the setting page, enter all the information needed to access this device in the **REQUIRED** column, and click **Get Type** to examine if the information you entered is correct. The device type will be detected properly.

Step4: (Optional) Configure the settings in the **OPTIONAL** column as needed.

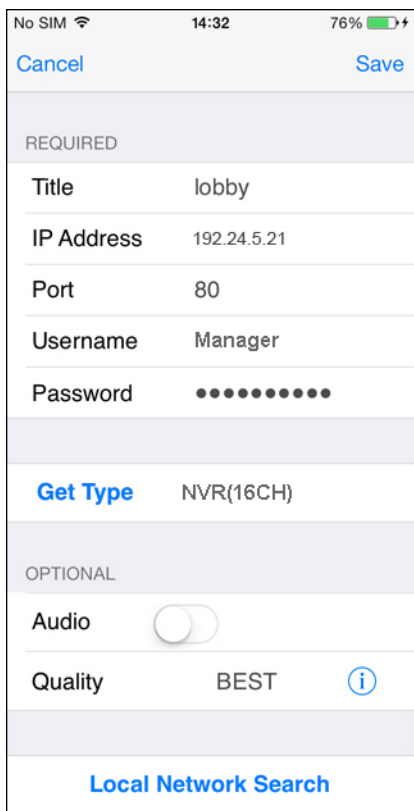

Step5: Click **Save** to return to the address book. Enable **Guard** to receive Push Video / Push Status.

Note: Push Video / Push Status is for selected models only. Before enabling **Guard**, please make sure if your device supports this function.

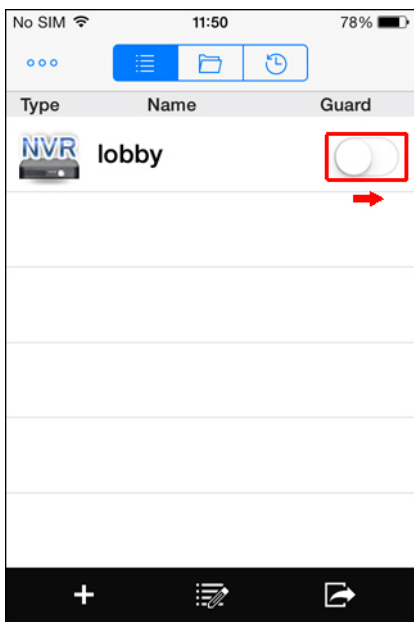

Step6: Click on the item you just added in the address book to access and check the live view.

APPENDIX 1 SPECIFICATIONS

■ 4CH Models

		Model 1	Model 2
▼ Video			
Video System		NTSC / PAL (auto detection)	
Video Compression Format		H.264	
Video Signal		IP / TVI / Analog HD / 960H	Analog HD / TVI / 960H
Video Input		4 quadbrid channels	4 tribrid channels
Video Input Interface	Analog Mode	Composite video signal 1 Vp-p 75Ω BNC	
	IP Mode	Ethernet, 10/100 Base-T	NO
Video Output	BNC	YES	
	VGA	YES	
	HDMI	YES	
Video Resolution	Analog Mode	1080P / 720P / QHD / 960H / Frame / Field / CIF	
	IP Mode	Live & Playback: 1920 x 1080 / 1280 x 720 / 640 x 480 / 320 x 240 Record**: 2592 x 1944 / 2048 x 1536 / 1920 x 1080 / 1280 x 720 / 640 x 480 / 320 x 240	NO
▼ Record & Backup			
Max. Recording Rate		Up to 120 IPS @ 1920 x 1080	
Recording Mode		Manual / Timer / Motion / Alarm / Remote	
Pre-alarm Recording		YES	
Playback Channel		4CH	
Quick Search		Time / Motion / Alarm search mode	
Backup Device		USB 2.0 flash drive / Network	
Regular Backup		YES	
▼ Audio			
Audio Input		1 audio input	
Audio Output		1 audio output (Mono)	
▼ General			
Hard Disk Storage		6TB SATA HDD x 2	
SATA Interface		YES	
eSATA Interface (For external disk array connection)		YES	NO
Image Quality Setting		SUPER BEST / BEST / HIGH / NORMAL	
USB Mouse Control		YES	
Motion Detection Area		16 × 12 grids per channel	
Motion Detection Sensitivity		3 adjustable parameters for accurate detection	
Event Notification		Push Video / Push Status / FTP / E-Mail	Push Status / FTP / E-Mail
Picture Zoom		2X digital zoom	
PTZ Control		YES	
Alarm I/O		4 inputs, 1 output	NO
RS485		YES	
IR Remote Control		YES (IR receiver built-in)	
Key Lock (Password Protection)		YES	
User Level		4 user levels for different access privilege	
Video Loss Detection		YES	
Camera Title		Supports up to 25 letters	

	Model 1	Model 2
▼ General		
Video Adjustable	Hue / Saturation / Contrast / Brightness	
Date Display Format	YY/MM/DD, DD/MM/YY & MM/DD/YY	
Daylight Saving	YES	
Power Source (±10%)	DC12V / 3A	
Operating Temperature	10°C ~ 40°C (50°F~104°F)	
Operating Humidity	10% ~ 85%	
Dimensions (mm)***	345(W) × 58.8(H) × 223(D)	
Net Weight (kg)	2.17	---
▼ Network		
Ethernet	10/100 Base-T. Supports remote control and live view via Ethernet	
Network Protocol	TCP/IP, PPPOE, DHCP and DDNS	
▼ Remote Surveillance from PC		
Compatible Operating System	Windows & MAC	
Compatible Program	Web Browser:	Internet Explorer, Google Chrome & Safari
	CMS Lite:	24CH central management software for Windows OS
	QuickTime:	For both Windows and MAC operating systems
Max. online users	20	
Web Transmitting Compression Format	H.264	
Network Live Audio	YES	
Remote Independent Operation	YES	
Remote Event Download & Playback	YES	
▼ Mobile Surveillance		
App	EagleEyes	
Compatible Devices	iOS & Android mobile devices	
Push Video	YES (4CH)	NO
Push Status	YES	
▼ Others		
EaZy Networking	YES	
IVA Support	YES (4 channels in analog mode)	NO
DCCS Support	YES	
Free DDNS service	YES	
Privacy Mask	YES	
Multiplex Operation	Live display / record / playback / backup / network operations	
System Recovery	System auto recovery after power failure	
Optional Peripherals	Disk Array (AVX997 / AVX992) / HDMI Matrix (HDM02) / USB Joystick (AVX102)	HDMI Matrix (HDM02) / USB Joystick (AVX102)

* The specifications are subject to change without notice.

** To see 5MP video playback, you need to backup the footage and play on PC.

*** Dimensional tolerance: ±5mm

■ 8CH Model

		Model 3	Model 4	Model 5	Model 6
▼ Video					
Video System		NTSC / PAL (auto detection)			
Video Compression Format		H.264			
Video Signal		IP / TVI / Analog HD / 960H		Analog HD / TVI / 960H	
Video Input		8 quadbrid channels (IP / TVI / Analog HD / 960H) + 1 IP channel		8 tribrid channels	
Video Input Interface	Analog Mode	Composite video signal 1 Vp-p 75Ω BNC			
	IP Mode	Ethernet, 10/100 Base-T		NO	
Video Output	BNC	YES			
	VGA	YES (up to 1080P resolution)	YES		
	HDMI	YES (up to 4K2K resolution)	YES		
Video Resolution	Analog Mode	1080P / 720P / QHD / 960H / Frame / Field / CIF			
	IP Mode	2592 x 1944** / 2048 x 1536** / 1920 x 1080 / 1280 x 720 / 640 x 480 / 320 x 240	Live & Playback: 1920 x 1080 / 1280 x 720 / 640 x 480 / 320 x 240 Record**: 2592 x 1944 / 2048 x 1536 / 1920 x 1080 / 1280 x 720 / 640 x 480 / 320 x 240	NO	
▼ Record & Backup					
Max. Recording Rate	Analog Mode	Up to 240 IPS @ 1920 x 1080 (8 channels)	Up to 120 IPS @ 1920 x 1080 (8 channels) Up to 240 IPS @ 1280 x 720 (8 channels)		
	IP Mode	UP to 270 IPS @ 1920 x 1080 (9 channels)		--	
Recording Mode		Manual / Timer / Motion / Alarm / Remote			
Pre-alarm Recording		YES			
Playback Channel		9CH		8CH	
Quick Search		Time / Motion / Alarm search mode			
Backup Device		USB 2.0 flash drive / Network			
Regular Backup		YES			
▼ Audio					
Audio Input		4 audio inputs		1 audio input	
Audio Output (Mono)		1 audio output		1 audio output	
▼ General					
Hard Disk Storage		6TB SATA HDD x 3		6TB SATA HDD x 2	
SATA Interface		YES			
eSATA Interface (For external disk array connection)		YES		NO	
Image Quality Setting		SUPER BEST / BEST / HIGH / NORMAL			
USB Mouse Control		YES			
Motion Detection Area		16 × 12 grids per channel			
Motion Detection Sensitivity		3 adjustable parameters for accurate detection			
Event Notification		Push Video / Push Status / FTP / E-Mail		Push Status / FTP / E-Mail	
Picture Zoom		2X digital zoom			
PTZ Control		YES			

	Model 3	Model 4	Model 5	Model 6
▼ General				
Alarm I/O	8 inputs, 1 output	4 inputs, 1 output		4 inputs
RS485	YES			NO
IR Remote Control	YES (IR receiver built-in)			
Key Lock (Password Protection)	YES			
User Level	4 user levels for different access privilege			
Video Loss Detection	YES			
Camera Title	Supports up to 25 characters			
Video Adjustable	Hue / Saturation / Contrast / Brightness			
Date Display Format	YY/MM/DD, DD/MM/YY & MM/DD/YY			
Daylight Saving	YES			
Power Source (±10%)	19V / 3.42A	12V / 3A		
Operating Temperature	10°C ~ 40°C (50°F~104°F)			
Operating Humidity	10% ~ 85%			
Dimensions (mm)***	430(W) x 65(H) x 338(D)	345(W) x 68.3(H) x 225(D)		
Net Weight (kg)	--	2.17	---	
▼ Network				
Ethernet	10/100 Base-T. Supports remote control and live view via Ethernet			
Network Protocol	TCP/IP, PPPOE, DHCP and DDNS			
▼ Remote Surveillance from PC				
Compatible Operating System	Windows & MAC			
Compatible Program	Web Browser:	Internet Explorer, Google Chrome & Safari		
	CMS Lite:	24CH central management software for Windows OS		
	QuickTime:	For both Windows and MAC operating systems		
Max. online users	20			
Web Transmitting Compression Format	H.264			
Network Live Audio	YES			
Remote Independent Operation	YES			
Remote Event Download & Playback	YES			
▼ Mobile Surveillance				
App	EagleEyes			
Compatible Devices	iOS & Android mobile devices			
Push Video	YES (4CH)		NO	
Push Status	YES			
▼ Others				
EaZy Networking	YES			
IVA Support	YES (4 channels in analog mode)		NO	
DCCS Support	YES			
Free DDNS service	YES			
Privacy Mask	YES			
Multiplex Operation	Live display / record / playback / backup / network operations			
System Recovery	System auto recovery after power failure			
Optional Peripherals	Disk Array (AVX997 / AVX992) / HDMI Matrix (HDM02) / USB Joystick (AVX102)		HDMI Matrix (HDM02) / USB Joystick (AVX102)	

* The specifications are subject to change without notice.

** To see 5MP video playback, you need to backup the footage and play on PC.

*** Dimensional tolerance: ±5mm

■ 16CH Model

		Model 7	Model 8	Model 9
▼ Video				
Video System		NTSC / PAL (auto detection)		
Video Compression Format		H.264		
Video Signal		IP / TVI / Analog HD / 960H	Analog HD / TVI / 960H	
Video Input		16 quadbrid channels (IP / TVI / Analog HD / 960H), within which IP channels are up to 9 channels	16 tribrid channels	
Video Input Interface	Analog Mode	Composite video signal 1 Vp-p 75Ω BNC	Composite video signal 1 Vp-p 75Ω BNC	
	IP Mode	Ethernet, 10/100 Base-T	NO	
Video Output	BNC	YES		
	VGA	YES (up to 1080P resolution)	YES	
	HDMI	YES (up to 4K2K resolution)	YES	
Video Resolution	Analog Mode	1080P / 720P / QHD / 960H / Frame / Field / CIF		
	IP Mode	2592 x 1944** / 2048 x 1536** / 1920 x 1080 / 1280 x 720 / 640 x 480 / 320 x 240	NO	
▼ Record & Backup				
Max. Recording Rate	Analog Mode	Up to 240 IPS @ 1920 x 1080 (16 channels) Up to 480 IPS @ 1280 x 720 (16 channels)		
	IP Mode	UP to 270 IPS @ 1920 x 1080 (9 channels)	NO	
Recording Mode		Manual / Timer / Motion / Alarm / Remote		
Pre-alarm Recording		YES		
Playback Channel		16CH		
Quick Search		Time / Motion / Alarm search mode		
Backup Device		USB 2.0 flash drive / Network		
Regular Backup		YES		
▼ Audio				
Audio Input		4 audio inputs	1 audio input	
Audio Output (Mono)		1 audio output	1 audio output	
▼ General				
Hard Disk Storage		6TB SATA HDD x 3		
SATA Interface		YES		
eSATA Interface (For external disk array connection)		YES	NO	
Image Quality Setting		SUPER BEST / BEST / HIGH / NORMAL		
USB Mouse Control		YES		
Motion Detection Area		16 × 12 grids per channel		
Motion Detection Sensitivity		3 adjustable parameters for accurate detection		
Event Notification		Push Video / Push Status / FTP / E-Mail	Push Status / FTP / E-Mail	
Picture Zoom		2X digital zoom		
PTZ Control		YES		
Alarm I/O		8 inputs, 1 output	4 inputs	
RS485		YES	NO	
IR Remote Control		YES (IR receiver built-in)		
Key Lock (Password Protection)		YES		
User Level		4 user levels for different access privilege		

	Model 7	Model 8	Model 9
▼ General			
Video Loss Detection	YES		
Camera Title	Supports up to 25 letters		
Video Adjustable	Hue / Saturation / Contrast / Brightness		
Date Display Format	YY/MM/DD, DD/MM/YY & MM/DD/YY		
Daylight Saving	YES		
Power Source (±10%)	19V / 3.42A		
Operating Temperature	10°C ~ 40°C (50°F~104°F)		
Operating Humidity	10% ~ 85%		
Dimensions (mm)***	430(W) x 65(H) x 338(D)		
▼ Network			
Ethernet	10/100 Base-T. Supports remote control and live view via Ethernet		
Network Protocol	TCP/IP, PPPOE, DHCP and DDNS		
▼ Remote Surveillance from PC			
Compatible Operating System	Windows & MAC		
Compatible Program	Web Browser:	Internet Explorer, Google Chrome & Safari	
	CMS Lite:	24CH central management software for Windows OS	
	QuickTime:	For both Windows and MAC operating systems	
Max. online users	20		
Web Transmitting Compression Format	H.264		
Network Live Audio	YES		
Remote Independent Operation	YES		
Remote Event Download & Playback	YES		
▼ Mobile Surveillance			
App	EagleEyes		
Compatible Devices	iOS & Android mobile devices		
Push Video	YES (4CH)	NO	
Push Status	YES		
▼ Others			
EaZy Networking	YES		
IVA Support	YES (4 channels in analog mode)	NO	
DCCS Support	YES		
Free DDNS service	YES		
Privacy Mask	YES		
Multiplex Operation	Live display / record / playback / backup / network operations		
System Recovery	System auto recovery after power failure		
Optional Peripherals	Disk Array (AVX997 / AVX992) / HDMI Matrix (HDM02) / USB Joystick (AVX102)	HDMI Matrix (HDM02) / USB Joystick (AVX102)	

* The specifications are subject to change without notice.

** For 3MP / 5MP video recording, the local live display and playback only support sub stream display (D1 by default).

*** Dimensional tolerance: ±5mm

APPENDIX 2 PUSH VIDEO CONFIGURATION

Note: This function is for selected models only.

A2.1 Alarm Sensor Connection

Connect the alarm sensor, such as magnetic contacts, to the alarm-in port on the DVR rear panel. Alarm-in 1 corresponds to video channel 1, alarm-in 2 corresponds to video channel 2, and so on.

Note: The voltage restriction for alarm-in device connection is under DC24V 1A.

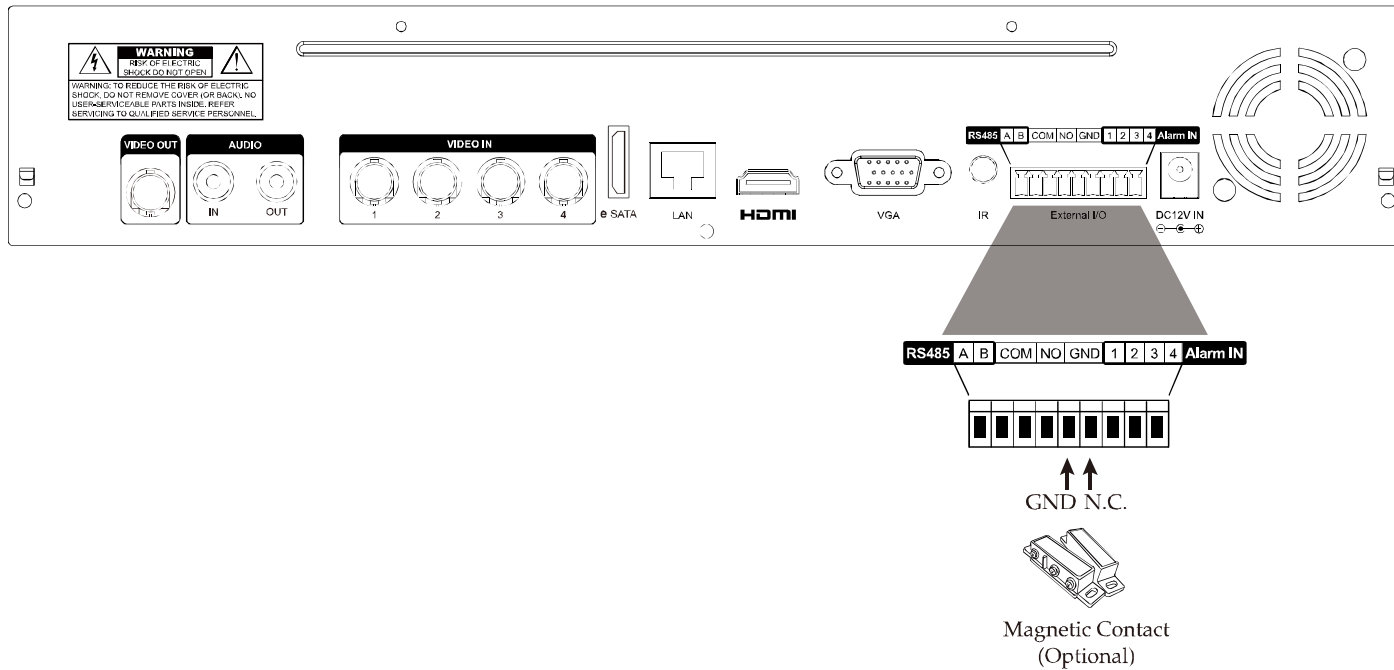

A2.2 Configuration

Before configuring Push Video, make sure:

1. The DVR system is set up as described in “2. CONNECTION AND SETUP” at page 4.
2. The DVR is connected to Internet.
3. You’ve installed the app, EagleEyes, on your iOS or Android mobile devices.
For details, please refer to “7.2 Mobile Devices” at page 61.

Step1: Right click to show the main menu.

Go to  (ADVANCED CONFIG.) → **NOTIFY**. In PUSH VIDEO, select the alarm device you want, and configure the alarm type. For details, please refer to “PUSH VIDEO” at page 48.

ADVANCED CONFIG					
CANERA DETECTION ALERT NETWORK DISPLAY RECORD DCCS NOTIFY JOYSTICK	PUSH VIDEO	PUSH STATUS	MESSAGE MAIL	MAIL	FTP
	RESET ALL GUARD CONNECTION				SUBMIT
	ALARM TRIGGERED DEVICE				ALARM IN 1 ▼
	CH01	ALARM OFF / INTERNAL ALARM ▼		CH1	
	CH02	ALARM OFF ▼		CH2	
	CH03	ALARM N.O. ▼		office	
	CH04	ALARM OFF ▼		CH4	
	EXIT				

Step2: Open EagleEyes, and add this DVR to the EagleEyes address book.

Step3: Enable Push Video as described below, and try to trigger your sensor to see if you can receive Push Video successfully.

1 Enable Push Video.



2 Trigger the input alarm.

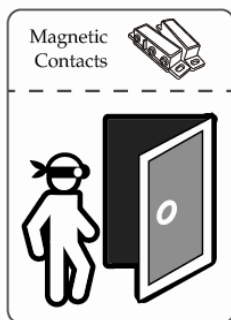

3 Receive an event notification and see video.



APPENDIX 3 SET PUSH VIDEO

This DVR series supports instant event notifications to your iOS / Android mobile device with our self-developed program, “EagleEyes”, installed. When a man is detected by an external alarm device, the DVR will immediately receive alarm signals and send to your iOS / Android mobile device.

Note: iOS and Android are the trademarks or registered trademarks of their respective holders.

1 Enable Push Video.



2 Trigger the input alarm.

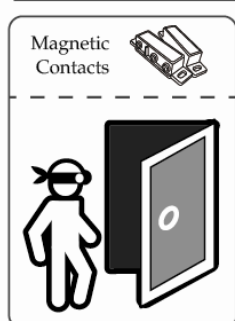

3 Receive an event notification and see video.

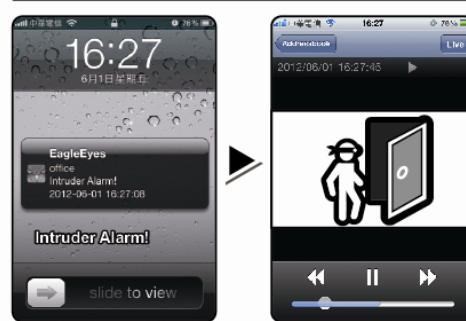

A3.1 Prerequisite

Before setting this function, make sure you have checked the following:

- ✓ You have an iOS or Android mobile device with our self-developed program, “EagleEyes”, installed. For details, please refer to the previous chapter.
- ✓ An external alarm device is connected to the external I/O ports on the rear panel. Make sure a camera is also connected to record for alarm occurrences. To know which video channel corresponds to which alarm pin, please refer to “APPENDIX 2 PUSH VIDEO CONFIGURATION” at page 69.
- ✓ The event record function of your DVR is not disabled.
- ✓ The motion detection function of your DVR is not disabled.
- ✓ Your DVR is connected to Internet. For details, please refer to www.surveillance-download.com/user/network_setup/network_setup_recorder.pdf.

A3.2 Enable Push Video

A3.2.1 From iOS Mobile Device (iPhone / iPad)

Step1: In the iPhone / iPad main menu, select **Settings** → **Notifications**. Select **EagleEyes**, and make sure the notification is set to on.

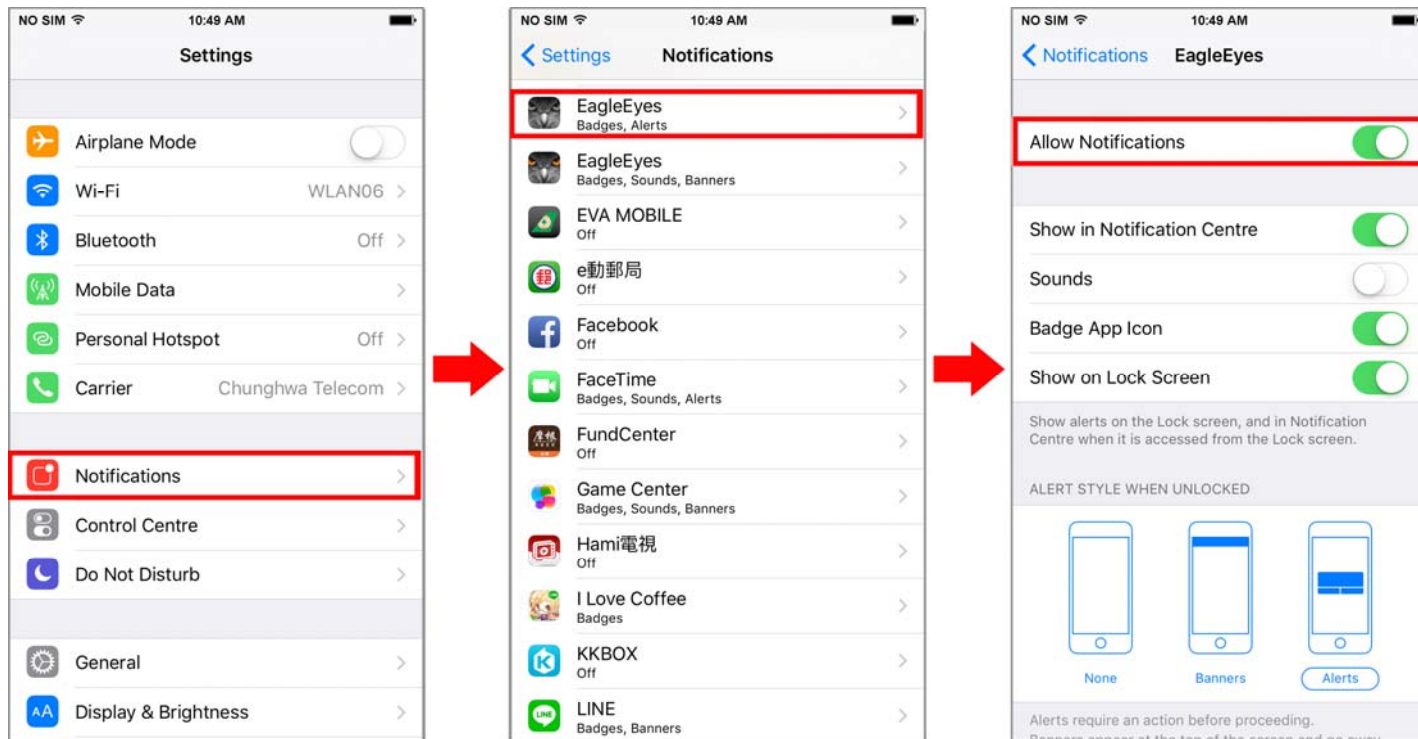

Step2: Open **EagleEyes**, and switch **Guard** to **ON**. You'll receive the message indicating that Push Video is on.

Step3: Return to the main page or standby page of iPhone / iPad. You'll receive event notifications when there's an alarm event. Follow the on-screen instruction to immediately play the recorded clip.

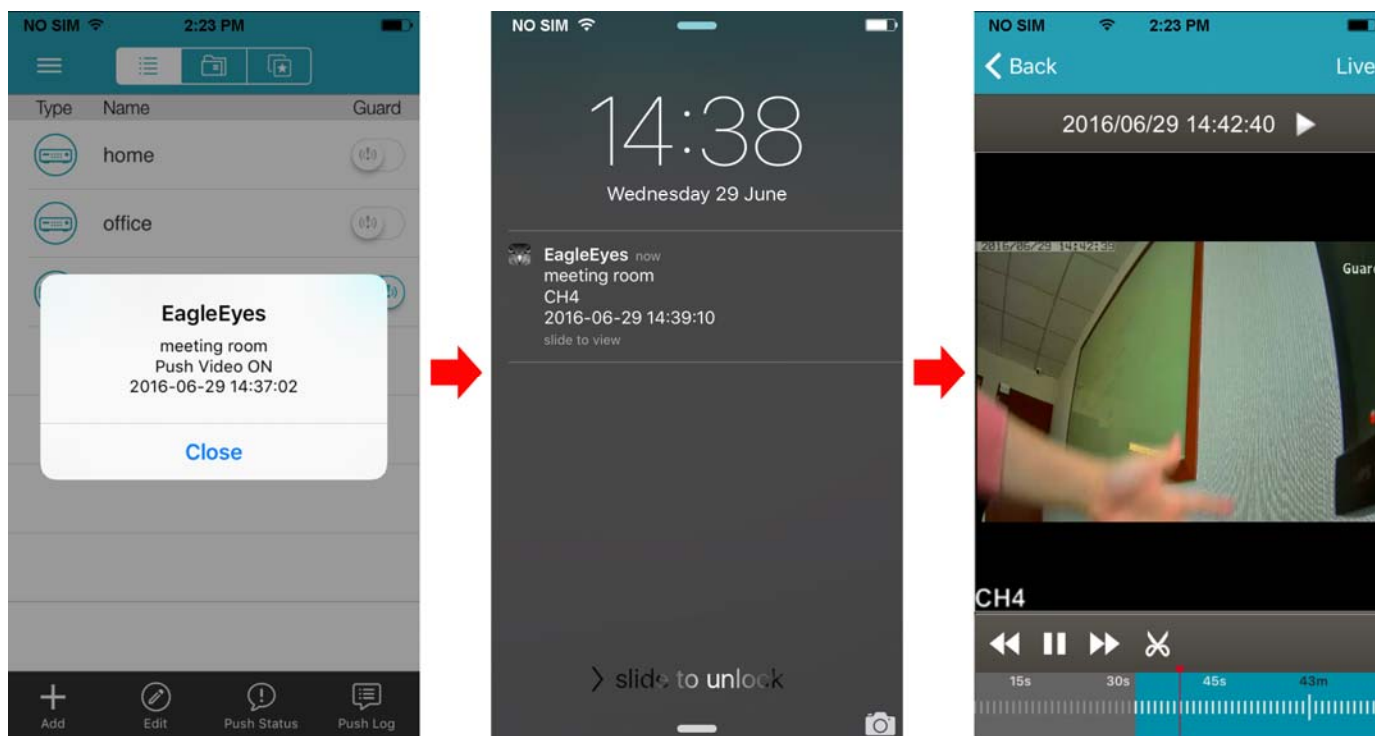

A3.2.2 From Android Mobile Device

In the address book, switch **Guard** from **OFF** to **ON**.

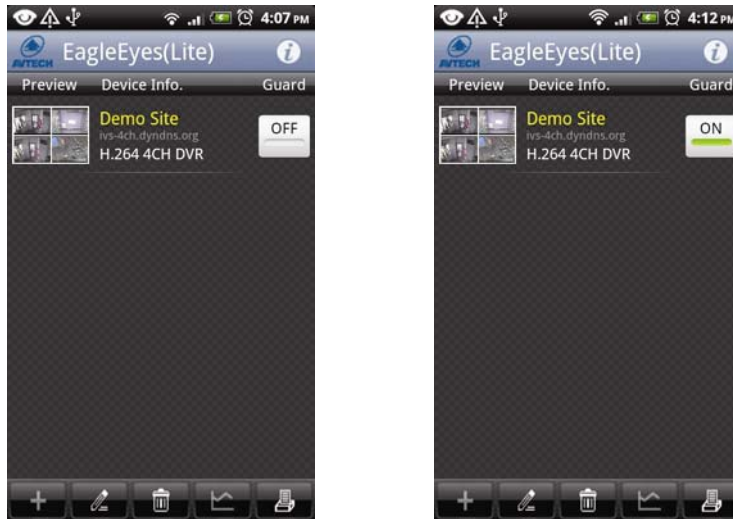

APPENDIX 4 COMPATIBLE USB FLASH DRIVE LIST

Please upgrade the firmware of the DVR to the latest version to ensure the accuracy of the following table. If the USB flash drive is not supported by the DVR, you will see  on the screen.

Note: Please use your PC to format the USB flash drive as "FAT32".

Note: You can backup up to 2GB video data for one-time USB backup. To backup more data, please set the time & channel(s) you want, and start USB backup again.

MANUFACTURER	MODEL	CAPACITY
Transcend	JFV35	4GB
	JFV30	8GB
Kingston	DataTraveler	1GB
PQI	U172P	4GB
Apacer	AH320	2GB
	AH320A	8GB
	AH220	1GB
	AH320	4GB
A-data	RB-18	1GB
Sandisk	Cruzer Micro	2GB
	Cruzer Micro	4GB
	Cruzer4-pk	2GB
Netac	U208	1GB
MSI	F200	4GB
SONY	Micro Vault Tiny 2GB	2GB
	Micro Vault Tiny 4GB	4GB
	Micro Vault Tiny	1GB

APPENDIX 5 COMPATIBLE SATA HDD LIST

Please upgrade the firmware of the device to the latest version to ensure the accuracy of the following table.

Note: It's necessary to install a hard disk first before firmware upgrade to ensure the upgrade process works properly.





Note: To use a green hard disk, use **ONLY** the hard disk designed especially for surveillance to ensure the device works properly.

Seagate*			
MODEL	CAPACITY	MODEL	CAPACITY
Pipeline HD ST3500312CS	500GB	ST3000VM002	3TB
Pipeline HD ST500VT000	500GB	ST3000VX004	3TB
Pipeline HD ST1000VM002	1TB	ST3000VX005	3TB
Pipeline HD ST1000VM002	1TB	ST3000VX006	3TB
ST31000525SV	1TB	ST3000VX000	3TB
ST31000340AS	1TB	ST4000VM000	4TB
ST1000VX000	1TB	ST4000VX002	4TB
ST1000VX002	1TB	ST6000VX0001	6TB**
ST1000VX001	1TB	ST6000VX0011	6TB**
ST2000VX000	2TB	ST6000NM0024	6TB**
ST2000DM001	2TB	ST8000VX002	8TB**
ST2000VX004	2TB		
WD			
MODEL	CAPACITY	MODEL	CAPACITY
WD10PURX	1TB	WD30EFRX	3TB
WD20PURX	2TB	WD40PURX	4TB
WD20EURS	2TB	WD40EURX	4TB
WD20EURX	2TB	WD60EURX	6TB**
WD20EFRX	2TB	WD60PURX	6TB**
WD2002FAEX	2TB	WD6001FFWX	6TB**
WD30PURX	3TB	WD6001FSYZ	6TB**
WD30EURX	3TB		
TOSHIBA			
MODEL	CAPACITY	MODEL	CAPACITY
DT01ACA050	500GB	MD03ACA200V	2TB
DT01ABA050V	500GB	DT01ABA300V	3TB
DT01ABA100V	1TB	DT01ACA300	3TB
DT01ACA100	1TB	MD03ACA300V	3TB
DT01ACA200	2TB	MD03ACA400V	4TB
DT01ABA200V	2TB	MD04ABA500V	5TB

* To know more details about SRS and its related support and service, please contact your local Seagate representative directly.

** Please be advised to pay attention to the heat dissipation of the hard disk which is over 4TB because it might generate much heat during operation. It's recommended that ambient temperature is not over 35°C.

APPENDIX 6 MAIN MENU STRUCTURE

	QUICK START	GENERAL	CHANNEL TITLE
			EVENT STATUS
			DATE DISPLAY
			DCCS DISPLAY
			MOUSE SENSITIVITY
		TIME SETUP	DATE
			TIME
			NTP SERVER
			FORMAT
			SYNC PERIOD
DAYLIGHT			
EaZy			
	SYSTEM	ACCOUNT	
		TOOLS	LANGUAGE
			UPGRADE
			NETWORK UPGRADE
			BACKUP CONFIG
			RESTORE CONFIG
			UPGRADE CAMERA PARAMETERS
			UPGRADE CAMERA FIRMWARE
		SYSTEM INFO	BAUD RATE
			HOST ID
			R.E.T.R.
			AUTO KEY LOCK(S)
			CLEAR HDD
			RESET DEFAULT
			REMOTE CONTROL ID
DEVICE TITLE			
SERIAL TYPE			
VIDEO FORMAT			
VERSION			
ONLINE	ANONYMOUS VIEWER LOGIN		
	LOGIN WITH CAPTCHA IMAGE		
	DROP ALL VIDEO CONNECTION		
	LOGIN FAILURE TIMES		
	LOCK TIME FOR LOGIN FAILURES		
BACKUP DATA			
BACKUP LOG			
	EVENT INFORMATION	QUICK SEARCH	
		EVENT SEARCH	
		HDD INFO	
		EVENT LOG	
	ADVANCED CONFIG	CAMERA	INTERFACE
			CAMERA TYPE* / CONNECTION*
			BRIGHTNESS
			CONTRAST
			SATURATION
			HUE
			REC
			TIME STAMP DISPLAY
			CHANNEL TITLE
			REC AUDIO
			ALARM OUT DURATION (SECS)

	ADVANCED CONFIG	DETECTION	LS
			SS
			TS
			MOTION
			ALARM
			AREA
			PRIVACY MASK
			INTERNAL ALARM*
			IPCAM GUARD LOCK
		ALERT	EXT. ALERT
			INT. BUZZER
			KEY BUZZER
			VLOSS BUZZER
			MOTION BUZZER
			ALARM BUZZER
			HDD BUZZER
			ALARM DURATION (SEC)
		ALERT	HDD NEARLY FULL (GB)
			HDD OVERHEAT ALERT (°C)
		NETWORK	WAN
			E-MAIL
			DDNS
			PROTOCOL
			EaZy
		DISPLAY	FULL SCREEN DURATION
			QUAD SCREEN DURATION*
			CALL SCREEN DURATION*
HDD DISPLAY MODE			
DISPLAY OUTPUT			
COMPOSITE OUTPUT			
CALL MONITOR PERMIT			
RECORD	MANUAL RECORD		
	EVENT RECORD		
	TIMER RECORD		
	PRE-ALARM RECORD		
	OVERWRITE		
	KEEP DATA LIMIT (DAYS)		
	RECORD CONFIG		
	SUBSTREAM RESOLUTION		
DEVICES*			
DCCS			
IVS*			
NOTIFY	PUSH VIDEO*		
	PUSH STATUS		
	MESSAGE MAIL		
	MAIL		
	FTP		
JOYSTICK			
	SCHEDULE SETTING	RECORD	
	DETECTION		
	ALARM IN*		
	ALARM OUT*		
	PUSH VIDEO*		
	BUZZER		
	REGULAR REPORT		
	AUTO BACKUP		
	REGULAR REBOOT		

*For selected models only

APPENDIX 7 DVR BATTERY REPLACEMENT

DVR time reset after power failure, for example, caused by a power outage, will cause the disorder of the recorded data, and users may have problems in searching the event clip they want. To keep the DVR time from resetting, a non-chargeable lithium battery, CR2032, is installed in the DVR.

However, the DVR time might still get reset when the DVR battery is low or even running out of power. If so, please replace the DVR battery, CR2032, **right away** as instructed below.

➤ How to replace CR2032

Note: The lithium battery, CR2032, is a non-chargeable battery, and should be purchased separately. Please replace only with the same or equivalent type battery in case of danger.

Step1: Stop all DVR recording **immediately** to prevent the disorder of the recorded data. Then, back up the recorded data if necessary.

Step2: Power off the DVR, and disconnect the DVR power.

Step3: Remove the DVR cover, and find the battery on the mainboard.

Step4: Push the release as indicated below to remove the battery.



Step5: Get a new battery with the side of “CR2032” facing up, and install it to the mainboard.

Step6: Replace the DVR cover and connect to power.

Step7: Set DVR date & time, and resume recording. For details, please refer to “6.1.2 TIME SETUP” at page 24, and “6.4.6 RECORD” at page 41.



APPENDIX 8 EAZY NETWORKING

EaZy Networking is a free P2P cloud service to connect AVTECH devices to the Internet automatically by plug-and-play, enabling you to check the live view via your mobile device or laptop at anytime (in 64 kbps). Should you feel the live view is not fluent enough and would like to speed it up, AVTECH provides several data plans for you to subscribe. We've also offered 2GB data allowance as a gift on each device for you to experience. When 2GB is up, the network transmission speed will restore to what it should be.

In most cases, the device is connected via P2P. Connection via the relay server is only applied to some complex environments such as the private IP-based network environment used by a large enterprise.



EaZy Networking could be configured via EagleEyes on an iOS / android device, or via Internet Explorer.

Before using this function, make sure:

- This DVR is connected to a switch or router, and the switch or router is ready for Internet connection.
- The network icon on the top right corner is , not .
- You have an iOS / Android mobile device with EagleEyes installed, or a PC / laptop with Internet Explorer installed.

A8.1 Via EagleEyes on iOS / Android Device

A8.1.1 Setup

Step1: Right-click to show the main menu, and select "NETWORK" → "WAN". Set "NETWORK TYPE" to "DHCP", and make sure the network icon on the top right corner is changed from  to .

Note: If the setting is made via the Setting Wizard, the network type will be automatically switched to DHCP.

ADVANCED CONFIG	
CAMERA	WAN E-MAIL DDNS PROTOCOL EaZy
DETECTION	NETWORK TYPE DHCP ▼
ALERT	IP 192.168.001.010
NETWORK	GATEWAY 192.168.001.254
DISPLAY	NETMASK 255.255.255.000
RECORD	PRIMARY DNS 8.8.8.8
DEVICES	SECONDARY DNS 168.95.1.1
DCCS	PORT 80
IVS	CHECK INTERNET AVAILABILITY BY ADDRESS www.google.com
NOTIFY	ENABLE UPNP OFF
JOYSTICK	
EXIT	MAC: 00:0E:53:EC:A7:B4

Step2: In the same menu, select "EaZy". Enable EaZy Networking, and leave this page open. You'll need to scan the QR code later.

QUICK START	
GENERAL	ENABLE EAZY NETWORKING ON
TIME SETUP	
DAYLIGHT	
EaZy	
	000E532B8613
EXIT	

Step3: Open EagleEyes on your mobile device, and select “...” on the top left corner in the address book. Then, click “⚙️”.

Step4: Click “Login” in the section of “Cloud” and register an account for “Cloud Service”. If you’ve got an account, please just log in.

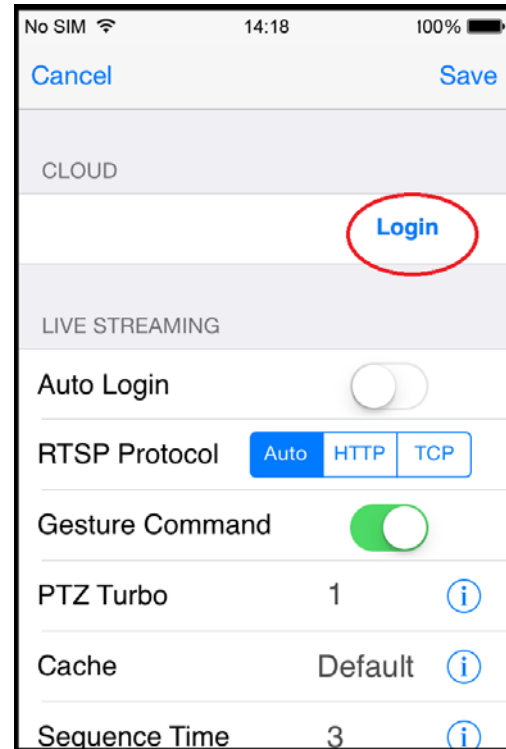
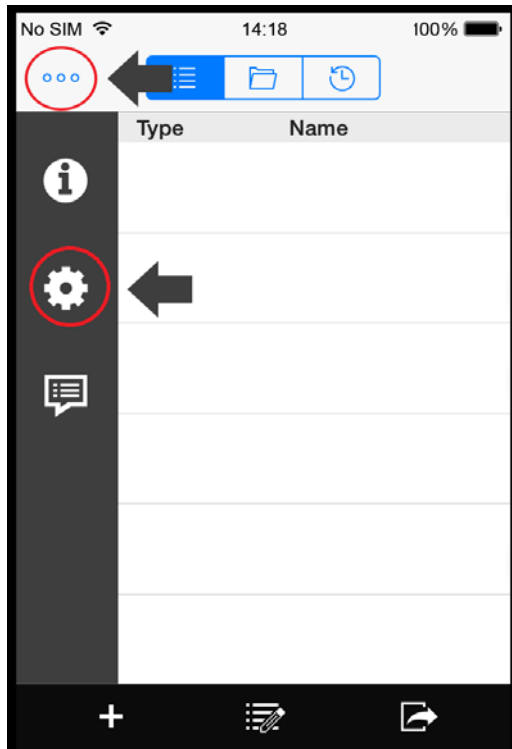

Step5: Go back to the address book and click “+” to add a new device.

There are two methods to add new devices, “EaZy” and “Manual”.
Select “EaZy”, and choose the DVR icon to continue.

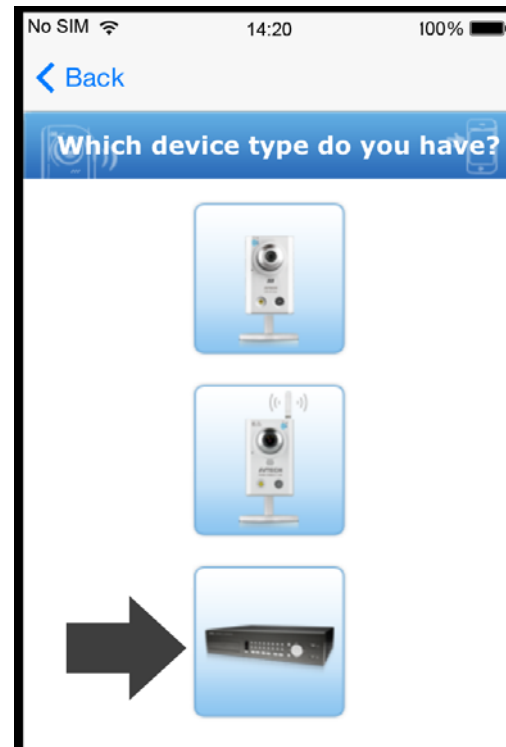
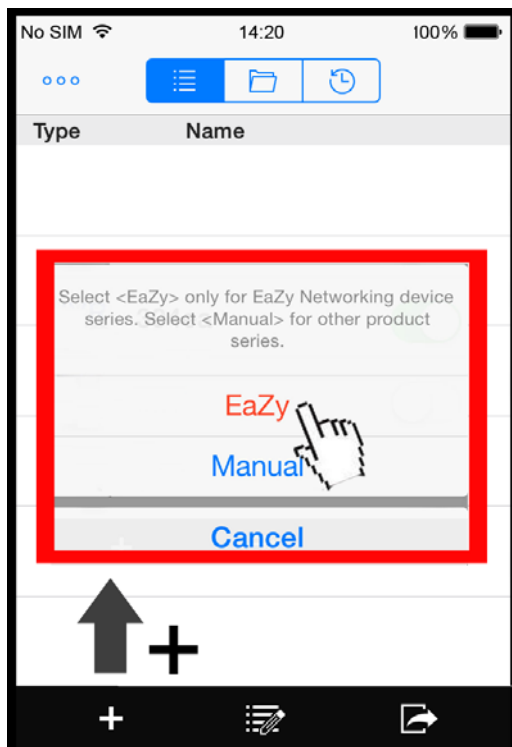

Step6: Click  in the section of “MAC address” to open the QR code scan page, and scan the QR code on the DVR screen mentioned in Step2. The MAC address will be filled automatically.

Fill in the Captcha code manually, and click “Apply”.

Step7: Follow the on-screen instruction to finish the rest of the settings, and see if this device is added successfully to the address book as a cloud device.

At the same time, you’ll be prompted to confirm if you want to remove the default user name and password.

- When the default user name and password are removed, you can **ONLY** use the user name and password of the cloud service to access this recorder locally and remotely. If you forget the user name and password of the cloud service, you could only reset the recorder and do all configurations again.
- When the default user name and password are kept, other people might be able to access this recorder if they know the default user name and password of this recorder.

Confirm if you want to keep the default account to continue, and return to the address book. You’ll see the newly-added device in the address with a cloud icon on it.

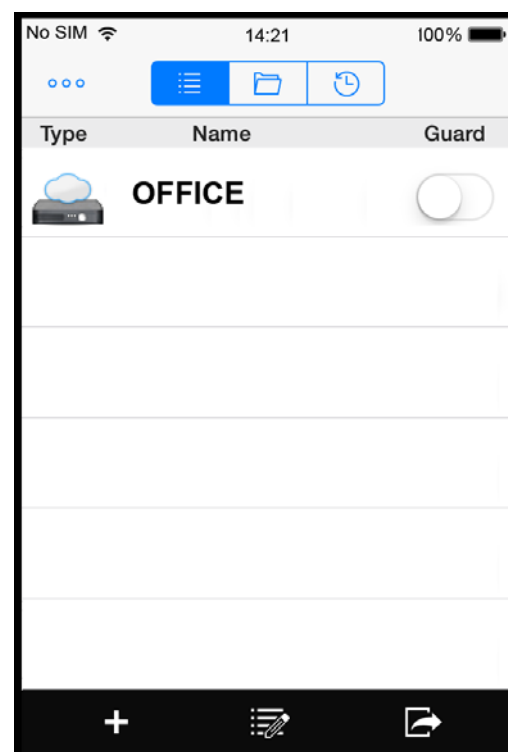

Step8: Click the newly-added device and see if you could access successfully.

A8.1.2 Checking Remaining Data Allowance

Step1: Log into the cloud service.

Step2: Select “Details” to go to account information, and select “Available Data Allowance”.

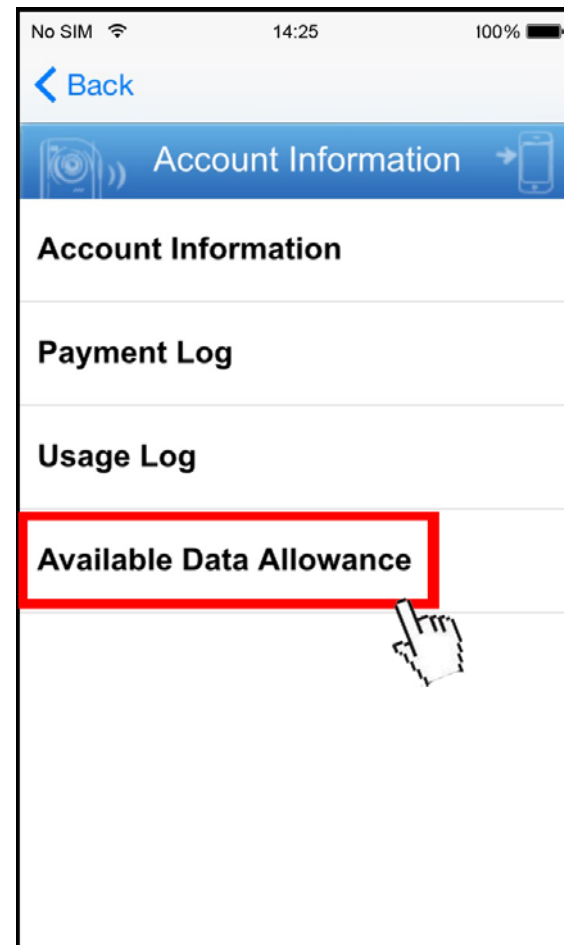
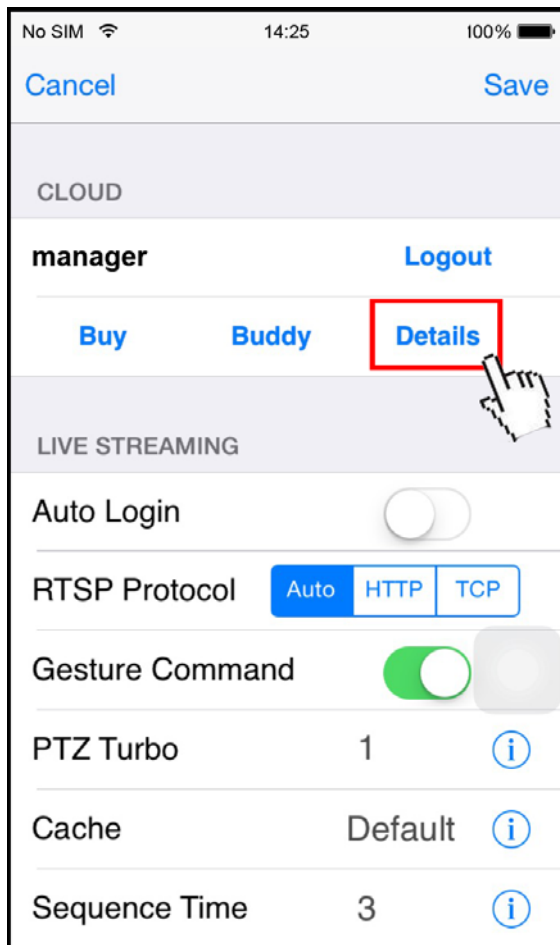

A8.1.3 Sharing Cloud Device Access to Other Account(s)

Note: One cloud device could be shared up to 30 cloud accounts, but the access to the device might be failed because it is still restricted to the maximum online user setup of the device.

Step1: Log into the cloud service.

Step2: Select “Buddy” to go to the buddy sharing page. Then, choose the cloud device you want to share, and switch from “OFF” to “Share”.

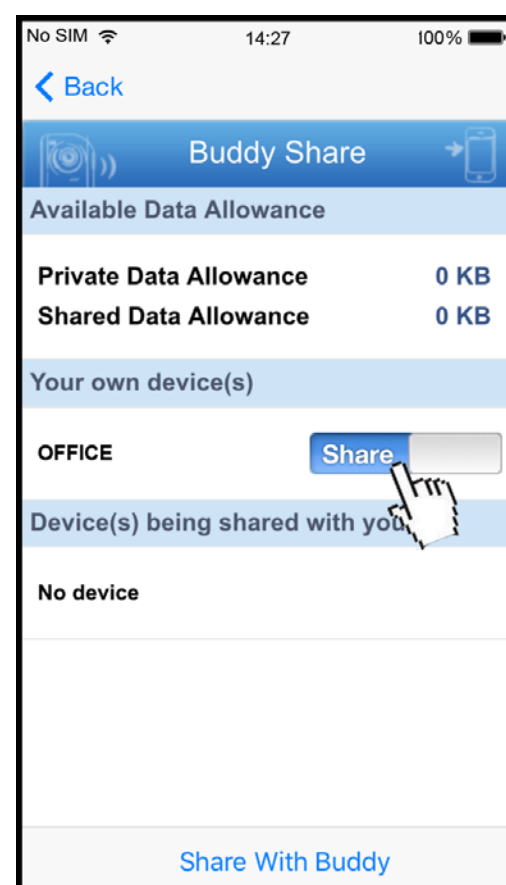
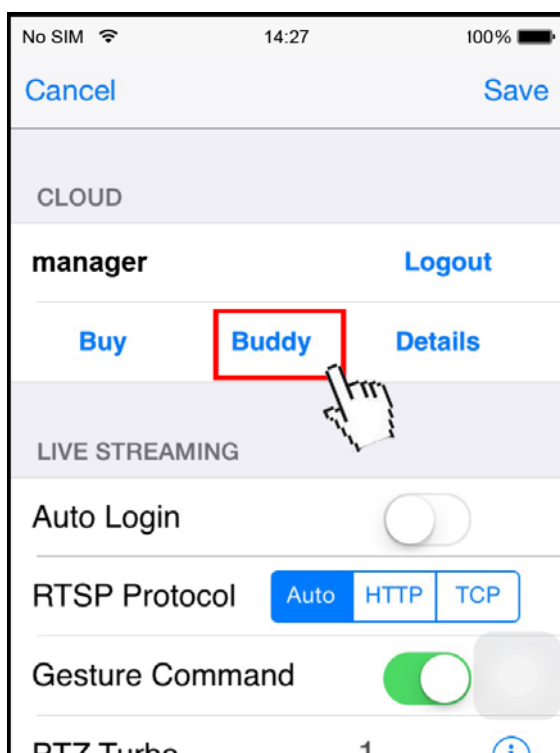

Step3: Enter the cloud account or the E-mail registered by the account, and select “Add”.

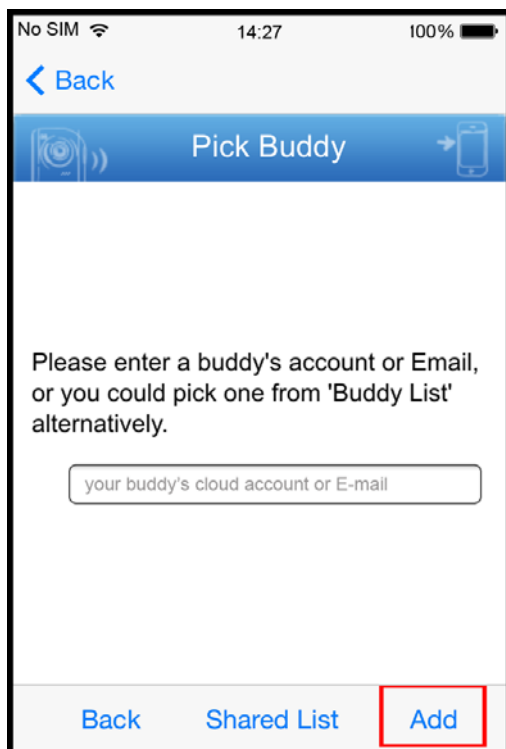

Step4: Check again the account to which you want to share your cloud device, and select “Next” to confirm and continue.

Step5: Specify the access permission of the specified account, which account’s data allowance should be consumed after access successfully, and how long the account is allowed to stay after access successfully.

➤ Who should pay data allowance:

Who should pay data allowance	The order to consume data allowance
I	The free data allowance provided by the device -> The additional data allowance shared to other account(s) by the owner -> The additional data allowance of the device’s owner -> The data allowance shared to other account(s) by the buddy
Buddy	The additional data allowance of the buddy -> The data allowance shared with other account(s) by the buddy

Note: When there’s no data allowance to use, the network transmission will be down to 1 FPS. To restore the fluency of live view, users need to subscribe a data plan from EagleEyes, or configure the network settings by themselves.

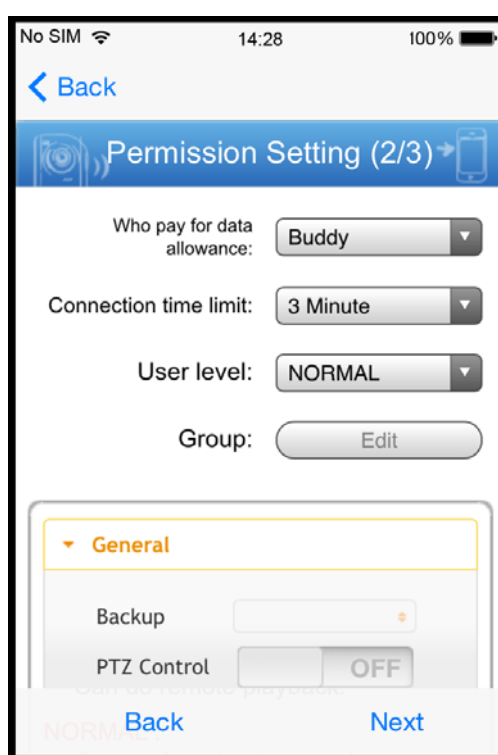
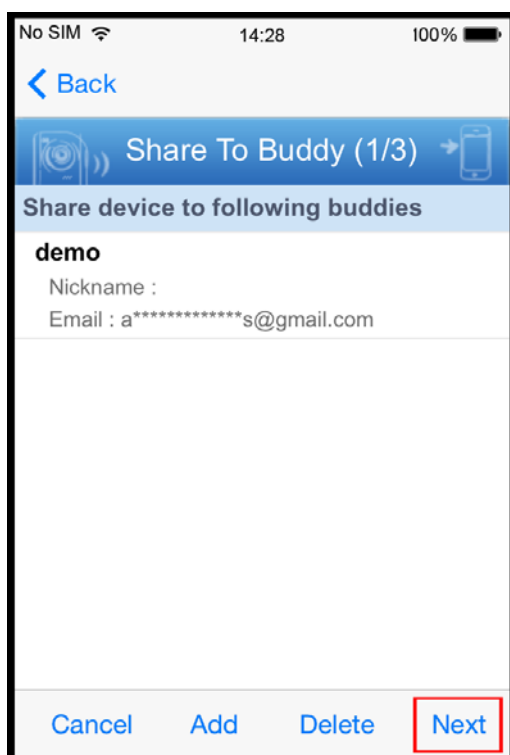

Step6: Check again the configurations you made for the account to which you want to share your cloud device, and select "Share!" to confirm.

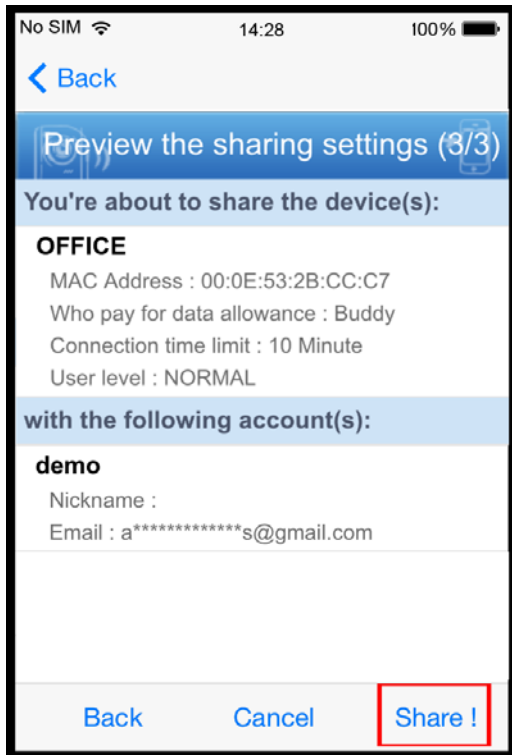

Step7: (Optional) Configure the data allowance shared to other accounts to use.



Step8: Return to the address book of EagleEyes. You'll see the device being shared is marked with an icon of two people.

A8.2 Via Internet Explorer on PC / Laptop

Note: EaZy Networking setup via a web browser is only available on Internet Explorer.

A8.2.1 Setup

Step1: Right-click to show the main menu, choose  (ADVANCED CONFIG), select "NETWORK" → "WAN".

Set "NETWORK TYPE" to "DHCP", and make sure the network icon on the top right corner is changed from  to .

Note: If the setting is made via the Setting Wizard, the network type will be automatically switched to DHCP.

ADVANCED CONFIG	
CAMERA	WAN E-MAIL DDNS PROTOCOL EaZy
DETECTION	NETWORK TYPE DHCP ▼
ALERT	IP 192.168.001.010
NETWORK	GATEWAY 192.168.001.254
DISPLAY	NETMASK 255.255.255.000
RECORD	PRIMARY DNS 8.8.8.8
DEVICES	SECONDARY DNS 168.95.1.1
DCCS	PORT 80
IVS	CHECK INTERNET AVAILABILITY BY ADDRESS www.google.com
NOTIFY	
EXIT	MAC: 00:0E:53:EC:A7:B4

Step2: In the same menu, select “EaZy”. Enable EaZy Networking, and write down the MAC address starting with “000E53” under the QR code. You’ll need it later.

ADVANCED CONFIG	
CAMERA DETECTION ALERT	WAN E-MAIL DDNS PROTOCOL EaZy ENABLE EAZY NETWORKING ON
NETWORK	 000E532B8613
DISPLAY RECORD DEVICES DCCS IVS NOTIFY	
EXIT	MAC: 00:0E:53:EC:A7:B4

ADVANCED CONFIG	
GENERAL	ENABLE EAZY NETWORKING ON
TIME SETUP	 000E532B8613
DAYLIGHT EaZy	
EXIT	

Step3: Open Internet Explorer on a PC / laptop, and enter <https://ez.eagleeyes.tw>.

In the login page, register an account for “Cloud Service”. If you’ve got an account, please just log in.

Note: You PC must be connected to Internet.

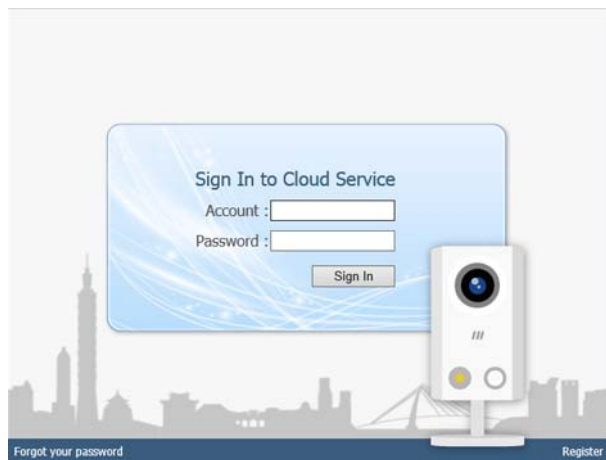

Step4: For the first time to access this website, you’ll be prompted to install a plugin: **EaZy Control**. Please install this plugin to ensure the service works properly.

Note: If you’re not prompted to install the plugin, please lower the security level of Internet Explorer, and try to log into the cloud service again.

Step5: Click “+” to add a new device and you’ll be prompted to install a program, **EaZy Wizard**. Follow the instructions to install this program.

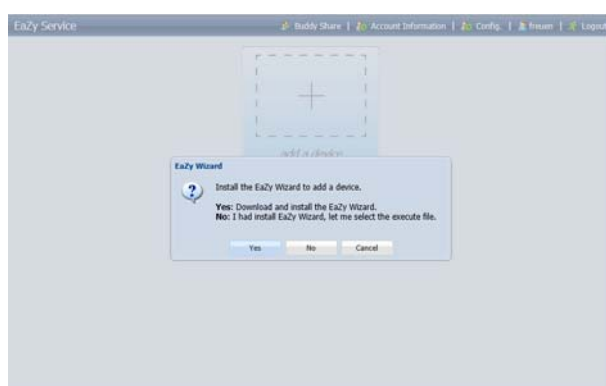

Step6: Enable EaZy Wizard, and click “Start” to go to the login page. Log into the cloud service.

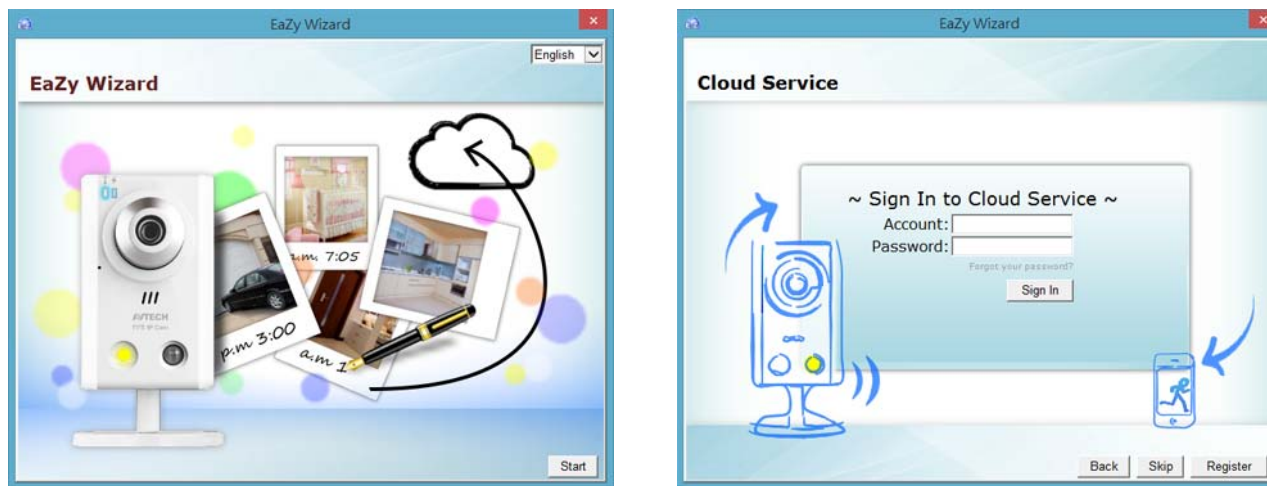

Step7: Select the recorder picture, or choose “DVR / NVR” on the bottom right corner. Then, enter the MAC address you wrote down in Step2, and the security code.

Click “Apply” to continue.

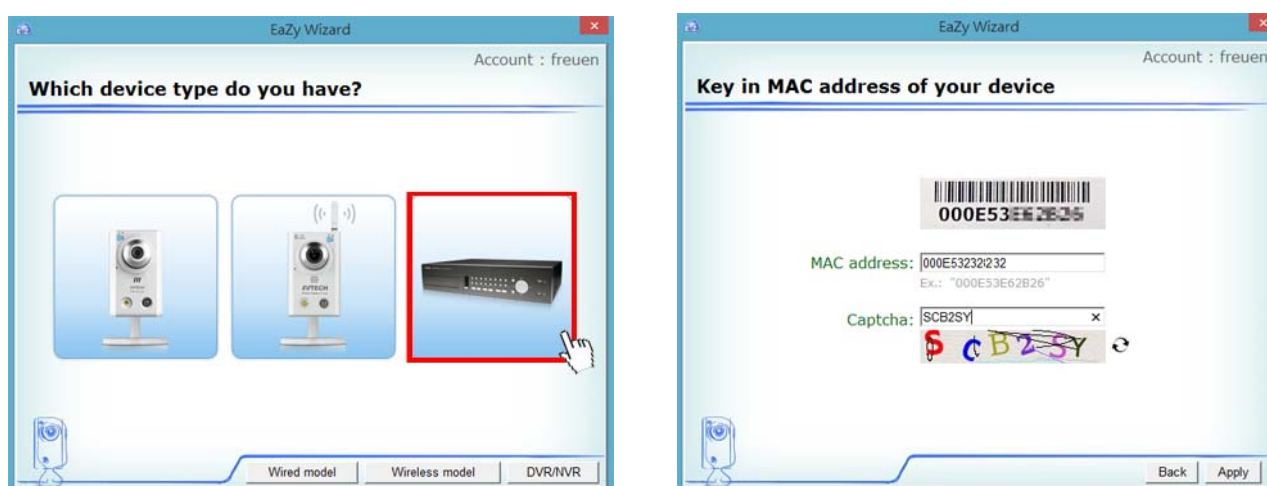

Step8: When your device is found, you’ll be directed to the next page to change the device title if you want.

Note: The device name changed here will be fixed and can’t be changed later.

Click “Apply” to continue. You’ll be prompted to confirm if you want to remove the default user name and password.

- When the default user name and password are removed, you can **ONLY** use the user name and password of the cloud service to access this recorder locally and remotely. If you forget the user name and password of the cloud service, you could only reset the recorder and do all configurations again.
- When the default user name and password are kept, other people might be able to access this recorder if they know the default user name and password of this recorder.

Confirm if you want to keep the default account, and click “Apply” to continue and return to the main page.

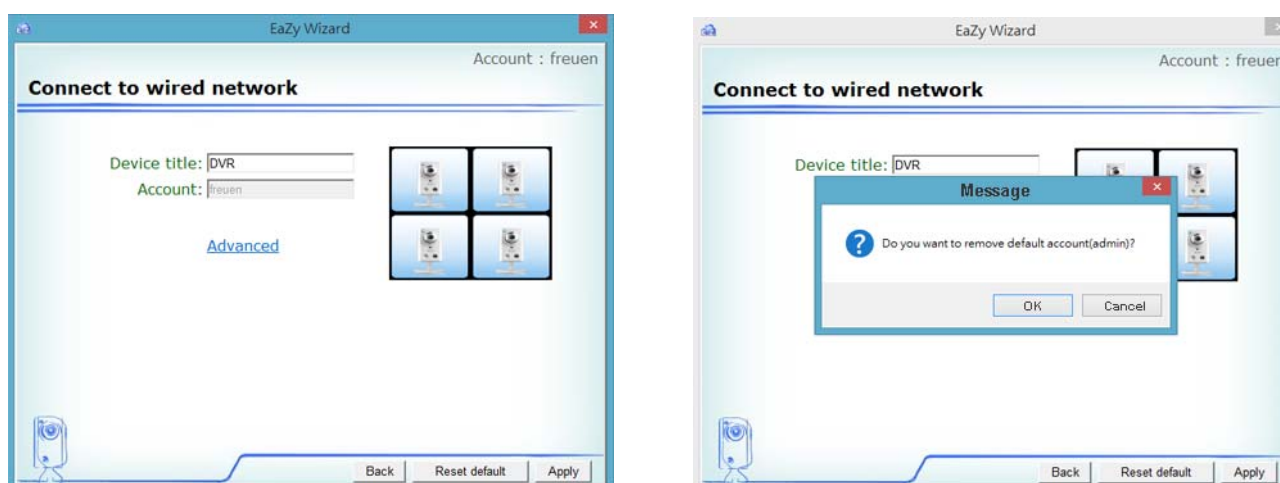

Step9: You'll see the newly-added device with a cloud icon on the main page. Click the device and see if you can access the device successfully.



A8.2.2 Checking Remaining Data Allowance

Step1: Log into the cloud service.

Step2: Select "Account Information" on the top right corner to go to account information, and select "Available Data Allowance".

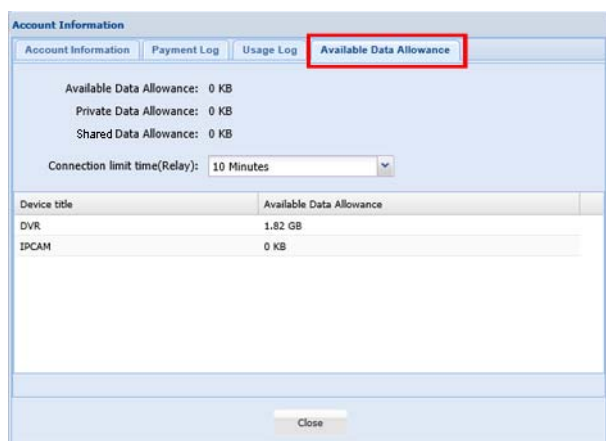

A8.2.3 Sharing Cloud Device Access to Other Account(s)

Note: One cloud device could be shared up to 30 cloud accounts, but the access to the device might be failed because it is still restricted to the maximum online user setup of the device.

Step1: Log into the cloud service.

Step2: Select "Buddy Share" to go to the buddy sharing page. Then, choose the tag "Your own device(s)", and select "Share With Buddy".

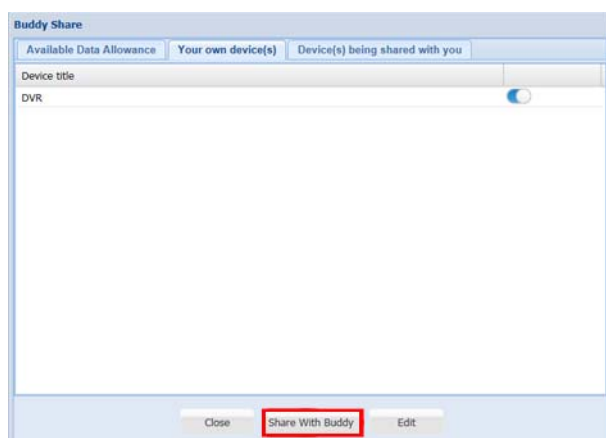

Step3: Choose the cloud device you want to share, and click “Next” to enter the cloud account or the E-mail registered by the account you want to share with. Then, select “Add”.



Step4: Check again the account to which you want to share your cloud device.

To add more accounts, select “Add”; to remove the existing account, select “Delete”; to continue buddy setup, select “Next”.

Step5: Specify the access permission of the specified account, which account’s data allowance should be consumed after access successfully, and how long the account is allowed to stay after access successfully.

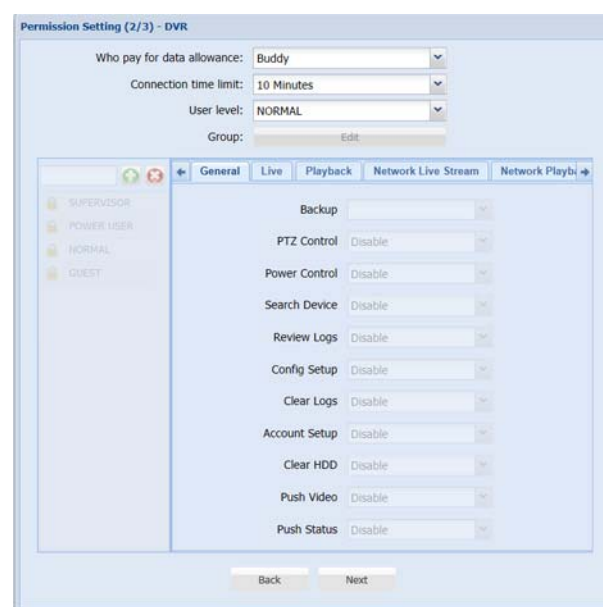
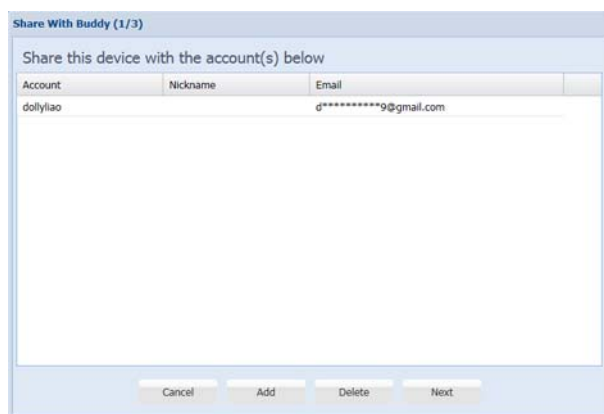

➤ Who should pay data allowance:

Who should pay data allowance	The order to consume data allowance
I	The free data allowance provided by the device -> The additional data allowance shared to other account(s) by the owner -> The additional data allowance of the device's owner -> The data allowance shared to other account(s) by the buddy
Buddy	The additional data allowance of the buddy -> The data allowance shared with other account(s) by the buddy

Note: When there’s no data allowance to use, the network transmission will be down to 1 FPS. To restore the fluency of live view, users need to subscribe a data plan from EagleEyes, or configure the network settings by themselves.

Step6: Check again the configurations you made for the account to which you want to share your cloud device, and select “Share!” to continue.

Step7: (Optional) Configure the data allowance shared to other accounts to use.

Step8: Return to the main page. You'll see the device being shared is marked with an icon of two people.

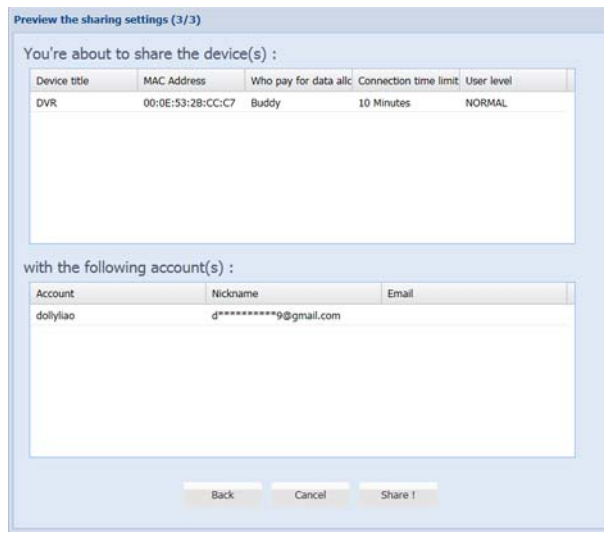

A8.3 Cloud Icons



Device connection ok



Device being shared to you and connection ok



Device shared to other account and connection ok



Device connection failed



Device being shared to you and connection failed



Device shared to other account and connection failed