

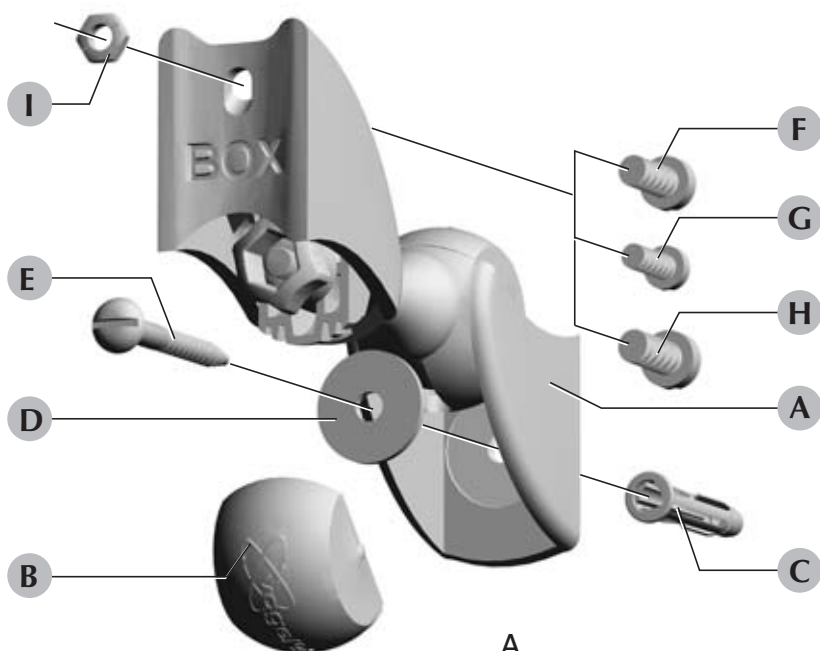







mm./inch.



A		2
B		4
C		2
D		2
E		2
F		2
G		2
H		2
I		2

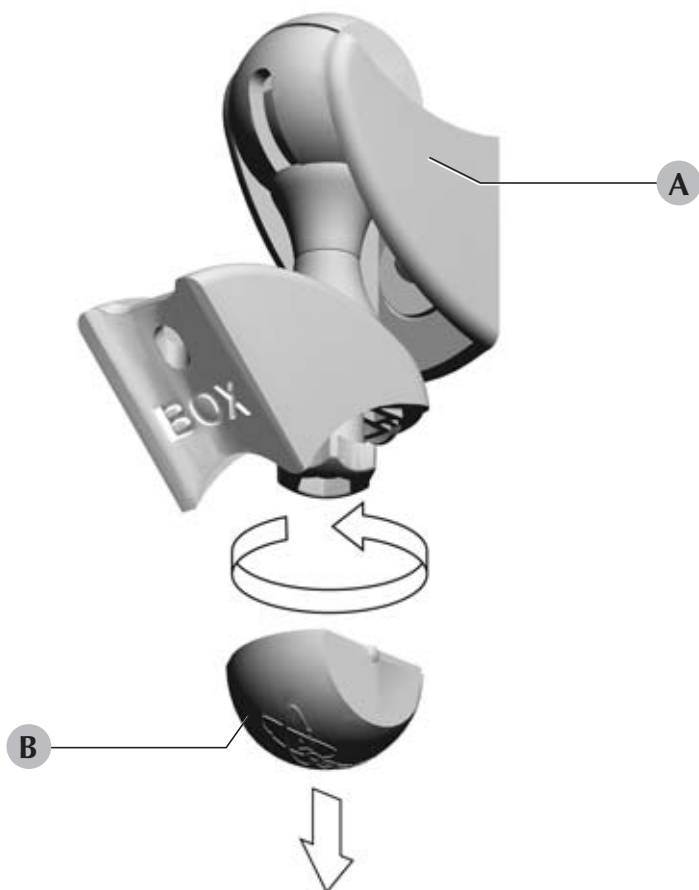

4

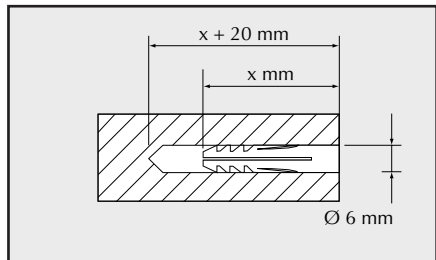
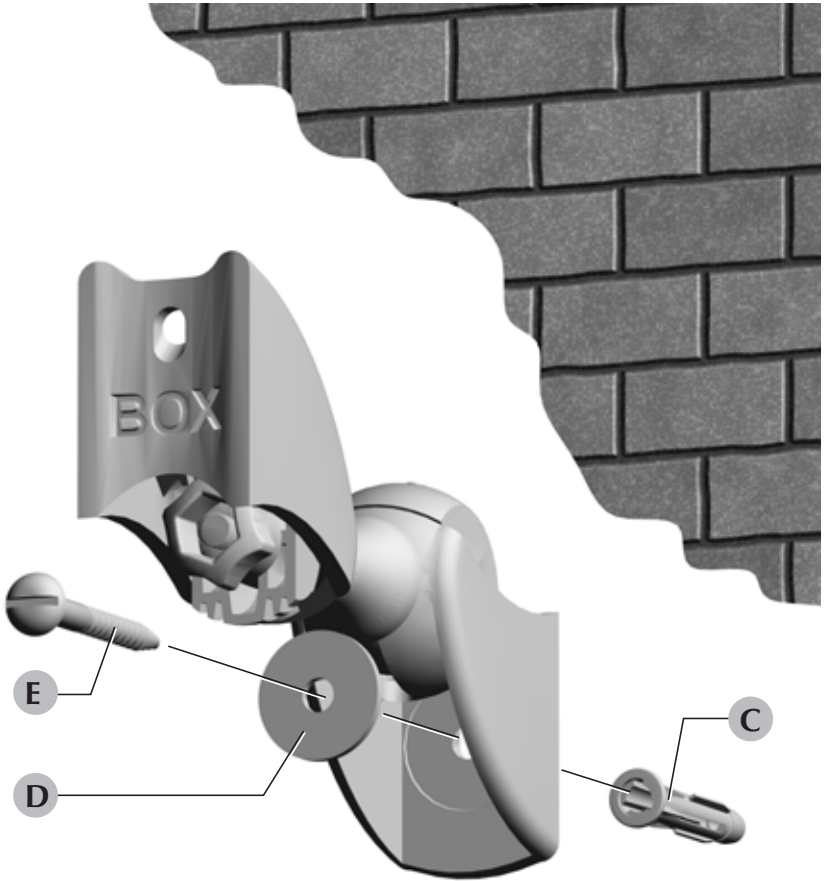

4a

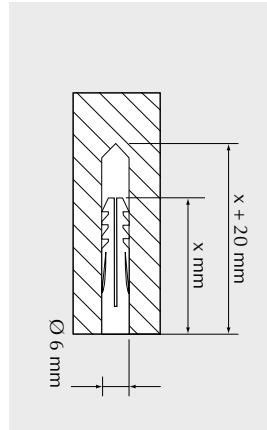
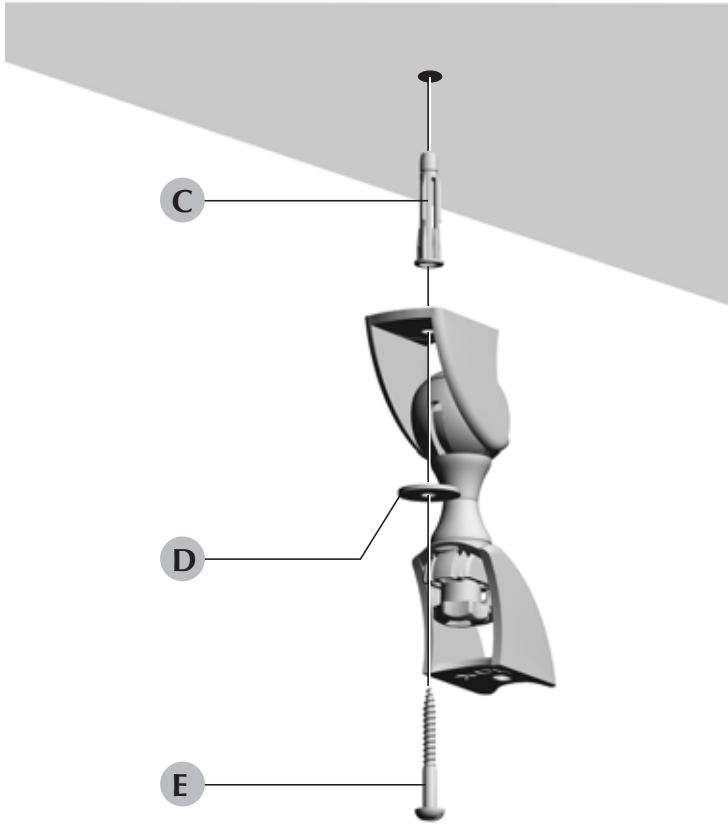

4b

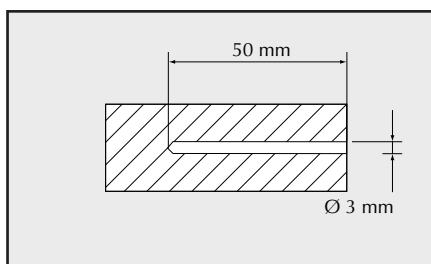
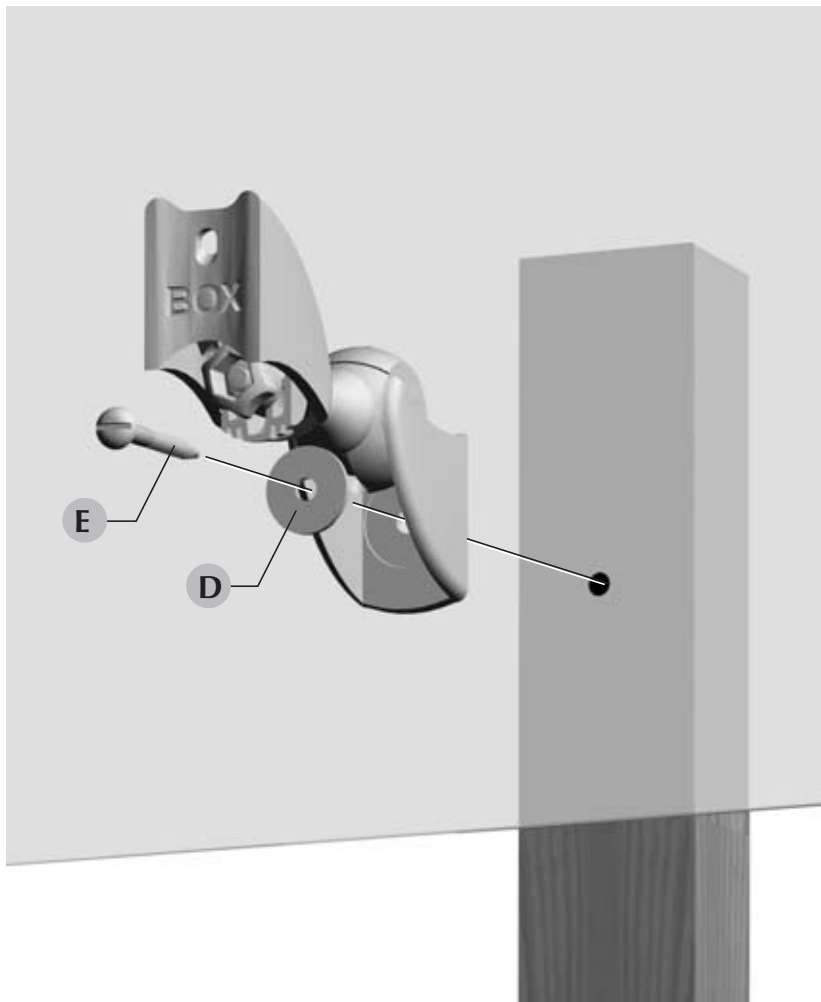

4c

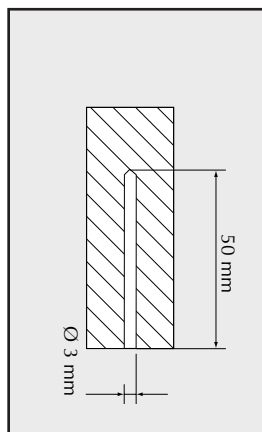
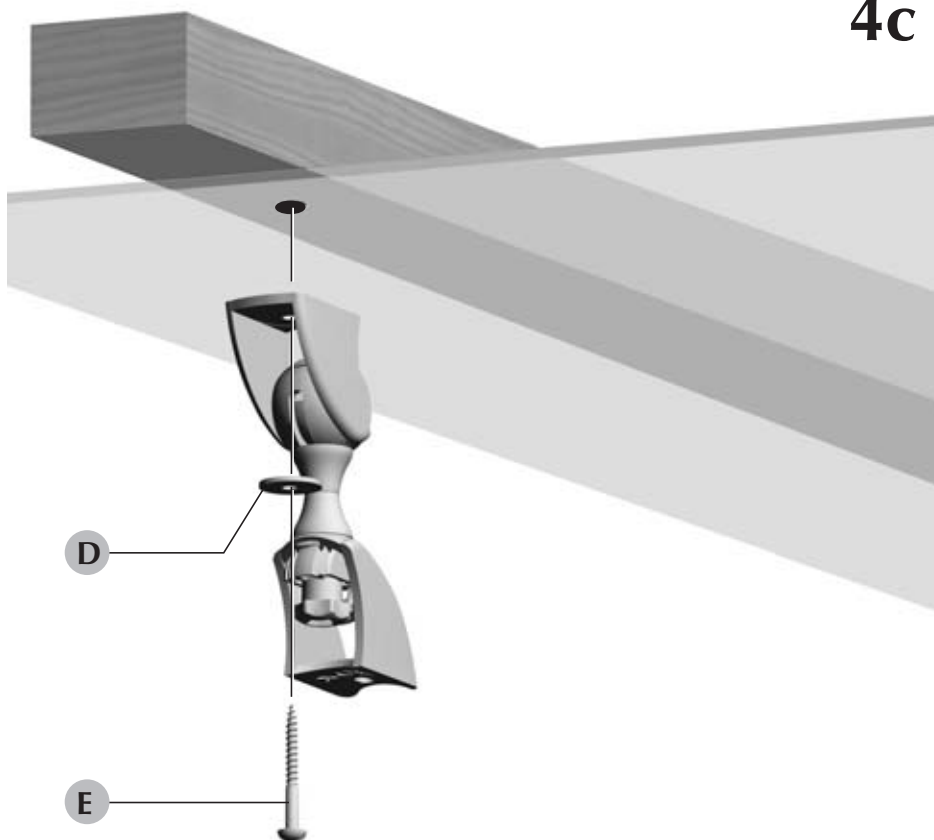

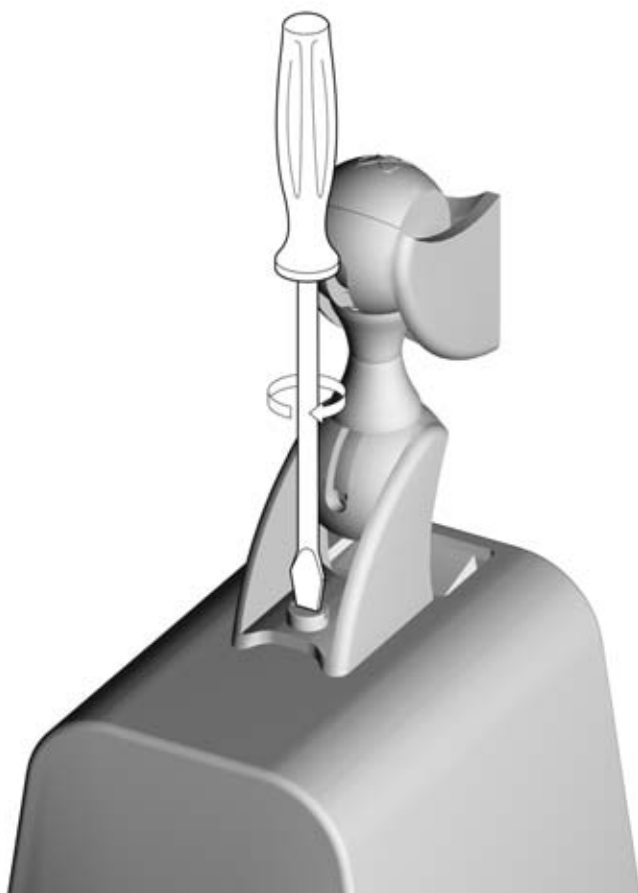

4c

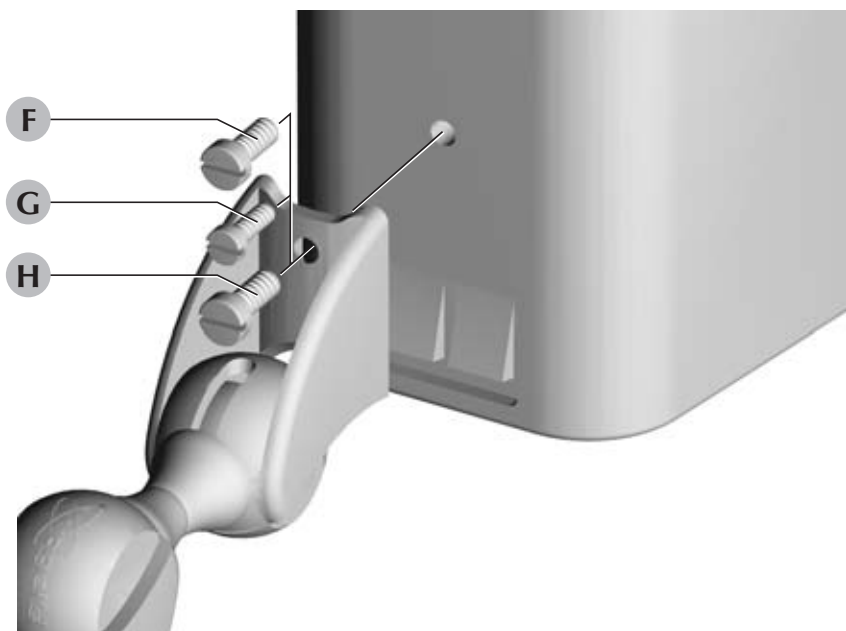

5b

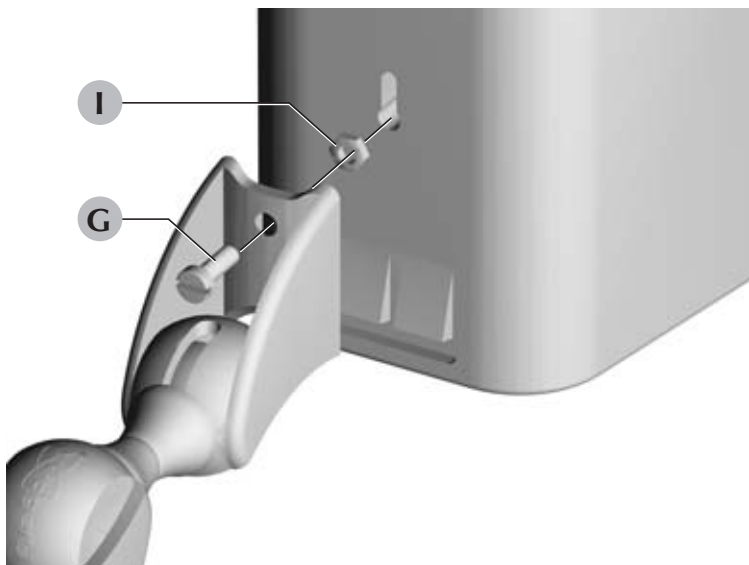

6

